

DBC0021F3V3-1

DIPLEXER 1800/2100

The Kaelus DBC0021 combiner provides diplexing of 1800 and 2100MHz bands wherever both signals are required on a single output. This may be at the BTS end of the feeder or at the antenna, saving infrastructure capital expenditure and improving network reliability.

FEATURES

- Combines 1800 and 2100 bands
- Options for bypassing DC and AISG internal to the diplexer
- Single or dual configurations available, suitable for indoor/outdoor use, wall or pole mounting kit
- Built in lightning protection on all ports



TECHNICAL SPECIFICATIONS

PORT NAME	1800	2100
Passband	1710 - 1880MHz	1920 - 2170MHz
Insertion loss	0.20dB typical, 0.3dB maximum	0.20dB typical, 0.35dB maximum
Return loss	20.7dB minimum	
EVM	0.3% typical / 2% maximum over 4.2MHz	
Group delay variation	7ns maximum	5ns maximum
Maximum input power	250W (average) / 1kW (PEP)	160W (average) / 1kW (PEP)
Intermodulation products	<-155dBc (2 x 20W, 3rd order)	
Attenuation COM to 1800		
698-960MHz	75dB min	N/A
1920 - 1980MHz	55dB minimum	N/A
2110 - 2170MHz	55dB minimum	N/A
2450 - 2900MHz	60dB minimum	N/A
Attenuation COM to 2100		
698 - 960MHz	N/A	50dB minimum
1710 - 1880MHz	N/A	55dB minimum
2450 - 2900MHz	N/A	60dB minimum
DC / AISG		
Passband	0 - 3MHz	
Insertion loss	1dB maximum	
Return loss	12dB typical	
DC current rating	2.5A/50V maximum	
ENVIRONMENTAL		
For further details of environmental compliance, please contact Kaelus.		
Temperature range	-40°C to +65°C -40°F to +149°F	
Ingress protection	IP67, outdoor	
Lightning protection	3kA maximum (10/3500us), IEC61312-1	
MTBF	>1,000,000 hours	

MECHANICAL	
Dimensions H x D x W (single unit)	270 x 200 x 53mm 10.62 x 7.87 x 2in
Dimensions H x D x W (twin unit)	270 x 200 x 112mm 10.62 x 7.87 x 4.4in
Weight	4.0kg 8.8lbs single unit 8.0kg 17.6lbs dual unit
Finish	Painted, light grey (RAL7035)
Connectors	DIN 7-16 (F) x 3 long neck (single unit) DIN 7-16 (F) x 6 long neck (twin unit)
Mounting	Pole/wall bracket supplied with two metal clamps for 45-178mm diameter poles

ORDERING INFORMATION

PART NUMBER	DESCRIPTION
DBC0021F3V1-1	Diplexer, DC/AISG path, common to 2100 port
DBC0021F3V2-1	Diplexer, DC/AISG path, common to 1800 port
DBC0021F3V3-1	Diplexer, DC/AISG path, common to 1800 and 2100 port
DBC0021F3V4-1	Diplexer, No DC/AISG paths fitted
DBC0021F3V21-2	Diplexer, DC/AISG path, common to 2100 port, twin unit
DBC0021F3V22-2	Diplexer, DC/AISG path, common to 1800 port, twin unit
DBC0021F3V23-2	Diplexer, DC/AISG path, common to 1800 and 2100 port, twin unit
DBC0021F3V24-2	Diplexer, No DC/AISG paths fitted, twin unit

ELECTRICAL BLOCK DIAGRAM

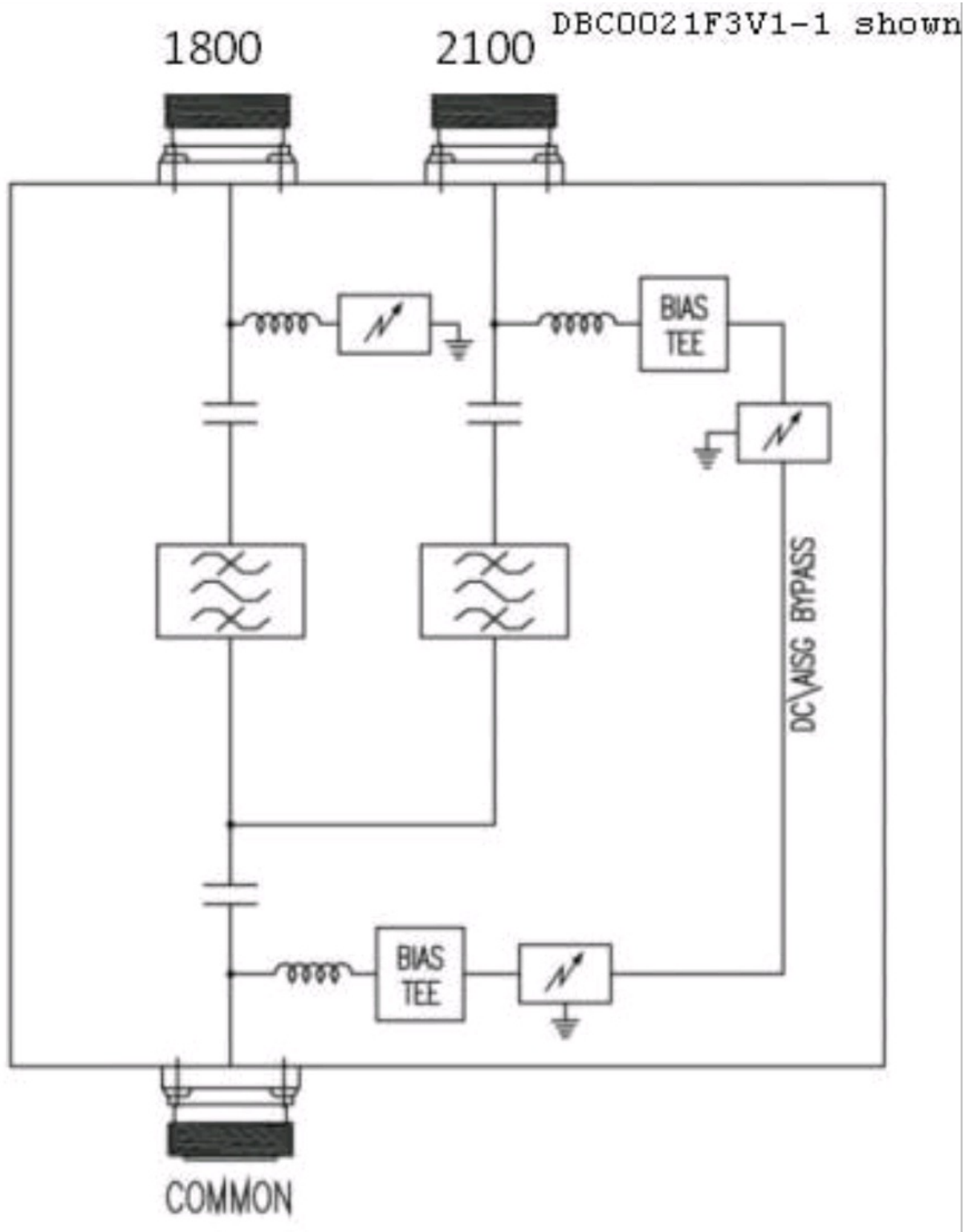

MECHANICAL BLOCK DIAGRAM

