

CLAMP ON POWER LOGGER PW3365

Power Measuring Instruments

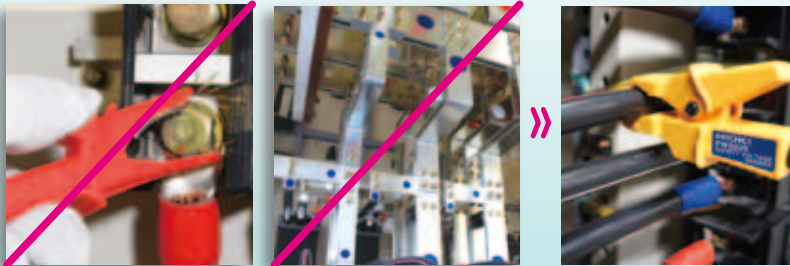

Eliminate the risk of short-circuits and electrical accidents



The world's first instrument to offer no-metal-contact power measurement

Free from the risk of short-circuit accidents since no metal comes into contact with energized parts, the Clamp On Power Logger PW3365-20 can measure voltage, current, and power right on the cable, letting you safely test in locations that were dangerous or even impossible in the past.

Safe, Easy, Voltage Measurement

The PW3365-20's dedicated voltage sensor delivers the world's first no-metal-contact measurement.

Free yourself from the risk of short-circuits by measuring right on the cable sheath without ever needing to touch metal to energized parts



Freely clip either horizontally or vertically

Measure both thick and thin cables

Measure in potentially hazardous locations



Locations without energized parts

Measure on the outside of cables



Locations with covered terminals

Measure without removing the covers



Locations with a risk of electric shock

Measure at safer points

How is voltage measured without any metallic contact?

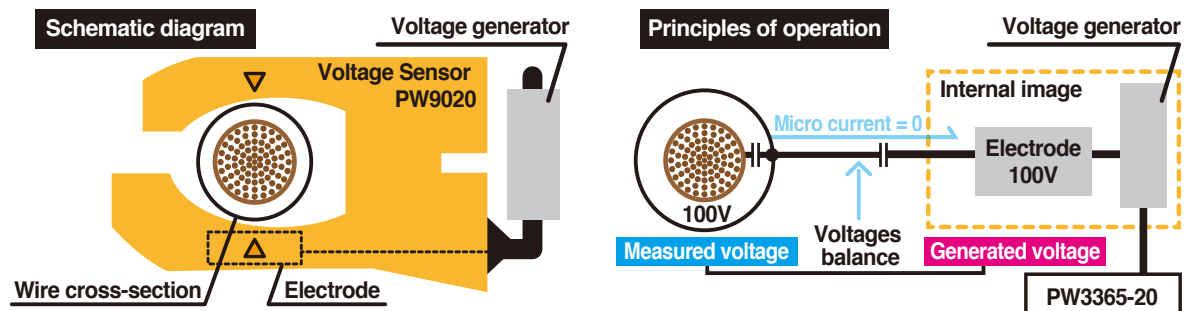

Inside the PW9020 is an electrode (a metal plate). When there is a potential difference between this electrode and the measured line, a minute current flows as a result. By detecting this minute current and generating a voltage such that the current declines to zero, it is possible to accurately measure the voltage without being affected by the outer diameter of the measured cable or its insulation.



Enlarged view of clamp

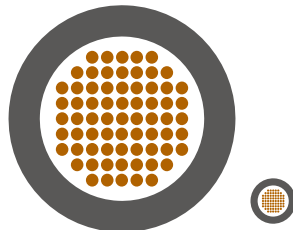

Actual maximum size : $\phi 30\text{mm}$
Actual minimum size : $\phi 6\text{mm}$

Compatible conductor diameters

SAFETY VOLTAGE SENSOR PW9020 Specifications

Compatible conductor types	Insulated wires* ¹ In door PVC or metal parts
Compatible conductor diameters	Finished outer diameter $\phi 6\text{mm}$ to $\phi 30\text{mm}$
Effective measurement range	90 V to 520 V
Accuracy	$\pm 1.5\%$ rdg. $\pm 0.2\%$ f.s. (combined accuracy with PW3365-20)* ²
Effect of phase	Accuracy combined with the PW3365-20 is within $\pm 1.3\%$ (at 50/60Hz, f.s. input)
Maximum rated voltage to earth	CATIV 300V / CATIII 600V
Cord length	3m (9.84 ft)
Mass	Approx. 220g (7.8 oz)
Operating temperature and humidity	0°C to 50°C (32°F to 122°F), 80% RH or less (no condensation)
Storage temperature and humidity	-10°C to 60°C (14°F to 122°F), 80% RH or less (no condensation)
Dielectric strength	7.06k Vrms AC
Applicable standards	Safety: EN61010, EMC: EN61326



* includes relay box on cord



Soil, residue, or moisture on the insulated wires may result in lower voltage and power values than their true values. Use a dry cloth to remove before measuring.

*1: Shielded wires cannot be measured.

*2: For frequencies of 45 Hz to 66 Hz.

Effects of humidity: Add the following to the combined accuracy (for voltage, power, and phase) with the PW3365-20 Accuracy within $\pm 1\%$ f.s., phase within $\pm 1^\circ$, measuring an insulated wire at a humidity of 70% to 80% RH
Effects of adjacent wires: Add the following to the combined accuracy (for voltage and power) with the PW3365-20 Within $\pm 1\%$ f.s. while a wire with a phase difference of 400 V is in contact with the grip

Configure Settings with Quick Set

Graphical, easy-to-understand guidance for connection procedures

Quick Setup guides you through the process of setting up the instrument for measurement, right up to starting measurement, on the screen to simplify set work. Since any mistaken connections will trigger a FAIL message, the feature also helps prevent measurement mistakes. If you receive a FAIL result, the instrument will also indicate the location of the problem.



Setup Flow (example: 3P4W)

STEP1 Quick Set START / Choose the wire type



STEP2 Connect the leads to the PW3365-20



STEP3 Connect the voltage sensor

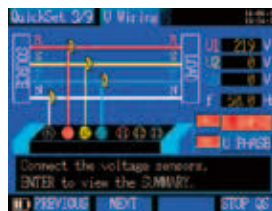

STEP4 Connect the clamp sensors



STEP5 Select the current range



STEP6 Check wire connection status

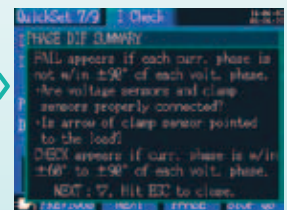
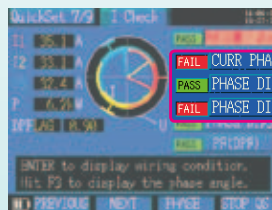

If you receive a FAIL result

Highlight the FAIL message with the cursor and press ENTER to view information about where the connection needs to be corrected.

Measurement

Miswiring Example (Clamp Orientation)

Neither power nor power factor can be measured accurately with the clamp in the wrong orientation.

Correct Orientation
Point the arrow toward the load side

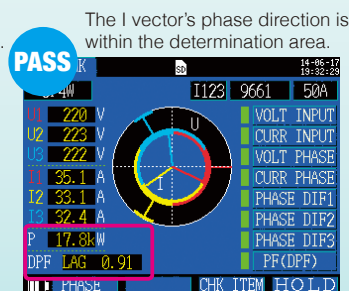
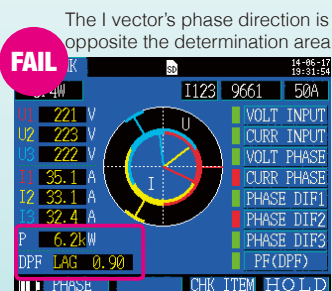
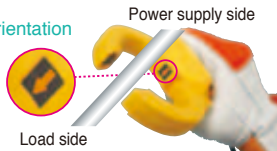

CURR PHASE Red means : FAIL VOLT PHASE Green means : PASS

Review Results At the Worksite

Display measured values as a graph and evaluate results at a glance

Measured values can be displayed as a graph, which is convenient when using the instrument in power management applications. Since you can statistically review not only the measured value at that moment, but also measured values that have been recorded, it's easy to check values on the spot.

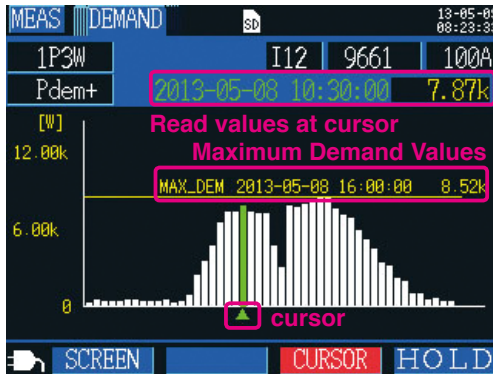

Bar graph of values measured over a period of 24 hours at a 30-minute interval

Demand Graph Display

Display demand value trends

It's easy to check the maximum demand value and the time at which it occurred.

Particularly useful in power management applications

Evaluate Photovoltaic Generation Capabilities

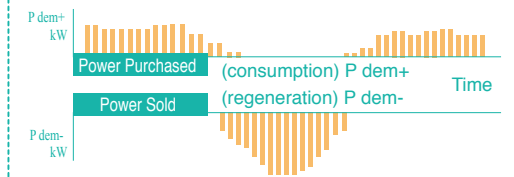

You can create a bar graph that makes it obvious whether power is being bought or sold by switching the active power demand value display from consumption to regeneration

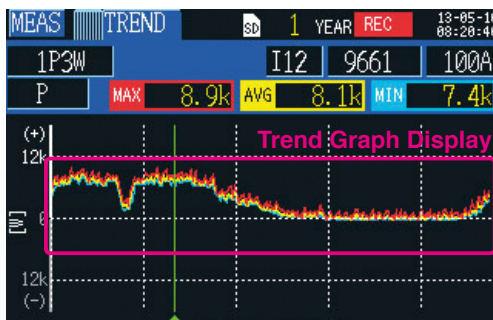

Trend Graph Display

* Except for demand

Choose one measured parameter to create a time-series display as a graph

Monitor power variations to check for connections between equipment operating status and power consumption.

Display the maximum, minimum, and average values at the cursor position

Identify these parameters right on the time-axis graph display

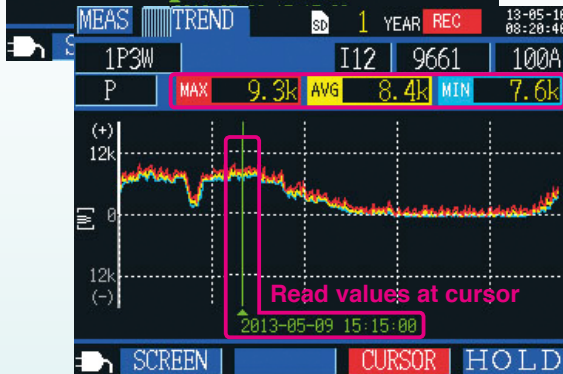

Graph of values measured over a period 24 hours at 5-minute intervals

Example Power trend graph display

- MAX 9.3k** Maximum Value
- MIN 7.6k** Minimum Value
- AVG 8.4k** Average Value

Capture and record all fluctuations

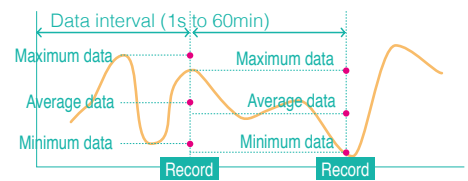

Set the power logger to save all parameters to record the maximum, minimum, and average values during the set recording interval.



Display electricity charges

Convert integrated power use to electricity charges

Know how much you are spending on electricity in real-time

Displaying electricity charges

Active power use 1 kWh × set rate



Calculate electricity charges

[Example screenshot to left]

The electricity charge per 1kWh has been set to \$20
Active power use 53.7306kWh × set rate 20 USD

electricity charges 1074.61 USD

Save & Analyze Results on a PC

Easily download and interpret data on a PC

Download the measurement results to a computer via the power logger's LAN or USB interface or its SD card. Once data has been downloaded, it can be graphed easily with free software. For more detailed analysis, Hioki's optional SF1001 application software is recommended.

Storage media for data

SD card 2GB

Stores up to one year's data that is acquired at one minute intervals. Performance cannot be guaranteed on storage media other than SD cards sold by Hioki.



Loading data

SD card 2GB

LAN interface

USB interface



Use the free software from the Hioki website in order to download data to a computer using the instrument's LAN or USB interface

Available Recording Time

Measurement Interval	Save Time	Measurement Interval	Save Time
1 seconds	15.6 days	30 seconds	1 year
2 seconds	31.2 days	1 minutes	1 year
5 seconds	77.9 days	2 minutes	1 year
10 seconds	155 days	5 minutes	1 year
15 seconds	233 days	More than 10 minutes	1 year

[Save conditions for above figures]

Measurement target : 3P4W
 Storage media : Z4001 2-GB SD card
 Saved parameters : All data: average, maximum, and minimum values
 Screen copy saving : OFF Waveform save : OFF

In all cases, the maximum single file size for measurement data is about 200 MB. When this is exceeded, a new file is created and saving continues.

Freeware (free download from the Hioki website)

Convenient Functions

- Load saved data directly from the instrument (via a USB/LAN connection)
- Graph saved data in Excel
- Transfer settings from a computer to the PW3365-20
- Print data

Automatically Create Excel Graphs

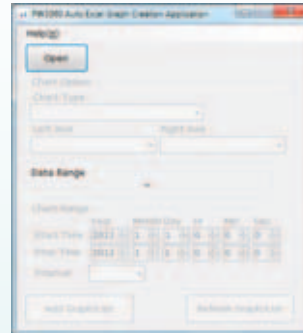

Power Logger Viewer SF1001 (option, sold separately/for PW3365, PW3360, PW3198)

Display, tabulate, analyze, and print saved data

- Trend graph display
- Summary display
- Waveform display
- Copy
- Print
- Report printing

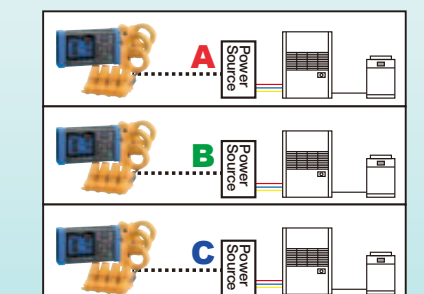

Example of a Stacked Graph Display

You can combine power consumption data measured at multiple locations into a single graph to capture the total power demand across a facility, allowing you to identify time periods and locations characterized by high power consumption at a glance.

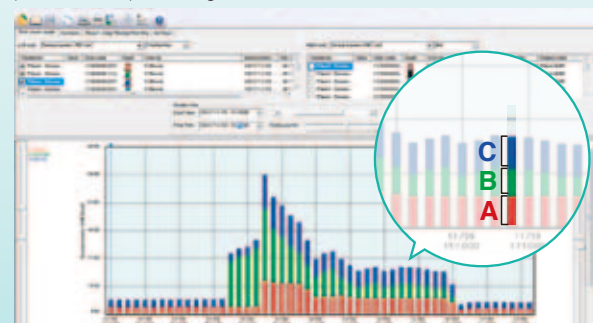

Convenient Functions For the Worksite

More Uses for the PW3365-20

The Hioki PW3365-20 is not just a power logger. Added-value features and functions let you meet many other electrical testing applications.

Leakage Current Measurement Requires optional clamp-on leak sensor

Measure power + 1-channel of leakage current

Example : 3P3W2M+1-channel leakage current

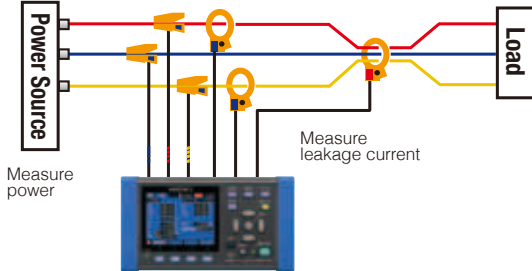

With the ability to calculate and process data every 200ms, you can do simple checks of intermittent leakage current. Choose from average, maximum and/or minimum value of the measured interval.

Leakage current results

MEAS	U/V	I	9675	50mA
3P3W2M+1				
U1	RMS (V)	FND (V)	PEAK (V)	PHASE (deg)
	224.4	224.4	321.1	0.0
U2	RMS (V)	FND (V)	PEAK (V)	PHASE (deg)
	223.3	223.3	326.0	59.9
U12	RMS (V)	FND (V)	PEAK (V)	PHASE (deg)
	223.5	223.5	322.5	-59.9
I1	RMS (A)	FND (A)	PEAK (A)	PHASE (deg)
	23.420	19.984	33.475	-29.9
I2	RMS (A)	FND (A)	PEAK (A)	PHASE (deg)
	22.079	18.952	44.459	90.3
I12	RMS (A)	FND (A)	PEAK (A)	PHASE (deg)
	25.604	19.445	62.660	-152.5
I3	RMS (A)	FND (A)	PEAK (A)	PHASE (deg)
	27.004m	24.924m	50.069m	59.5

By capturing the RMS of the fundamental wave, you can also identify the leakage current of the 50/60Hz component.

- RMS (A) RMS that includes harmonic components
- FND (A) RMS of fundamental wave
- PEAK (A) Peak value (waveform peak)

Measure 3 channels of leakage current

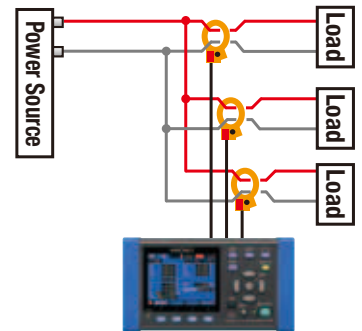

Control and monitor from a remote location

Use a LAN cable to connect the PW3365-20 to a personal computer for real-time remote monitoring and measurement display on a web browser.

Files recorded in the Clamp On Power Logger's internal memory or SD card are accessible via a LAN or USB connection, and are downloadable using the free PW3365-20 Setup and Download Software

Enter the IP address in the browser.

Display the power logger's screen and make adjustments virtually by clicking the buttons and entering new information.

Simultaneous Measurements

Measure three single-phase, 2-wire circuits in the same system at the same time.

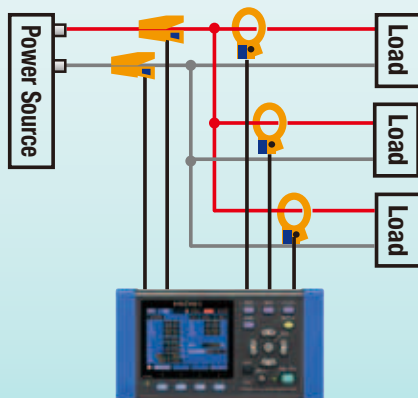

Other convenient features



Compact, lightweight

Small form factor lets you set the power logger even inside cramped cubicles



Battery power

Power the instrument for about five hours with batteries if the power goes out



Outage recovery

Resume recording automatically following recovery from a power outage

Key lock function

Lock the buttons to prevent erroneous operation

Display hold

Freeze the displayed value for easier reading

PW3365-20 Specifications

No dirt or moisture on insulated wire or voltage sensor
Product guaranteed for one year

Measurement				
Number of input channels	Voltage: 3 channels / Current: 3 channels			
Measurement targets (50/60Hz)	Single-phase 2-wire (1P2W, 1P2W × 2 circuits, 1P2W × 3 circuits) Single-phase 3-wire (1P3W, 1P3W+I, 1P3W1U, 1P3W1U+I) Three-phase 3-wire (3P3W2M, 3P3W2M+I, 3P3W3M/Y-wiring only) Three-phase 4-wire (3P4W), Current only: 1 to 3 channels			
Simultaneous power/current measurement modes	1P3W+I : 1 power circuit and 1 current channel 3P3W2M+I : 1 power circuit and 1 current channel			
Measurement items	Voltage	RMS value, fundamental wave value, waveform peak (absolute value), fundamental wave phase angle, frequency (U1)		
	Current	RMS value, fundamental wave value, waveform peak (absolute value), fundamental wave phase angle		
	Power	Active power, reactive power, apparent power, power factor, (with lag/lead display) or displacement power factor (with lag/lead display), active energy (consumption, regeneration, regeneration), reactive energy(lag, lead) Energy cost display (per-kWh price × power consumption)		
	Demand	Active power demand value (consumption, regeneration), reactive power demand value (lag, lead), active power demand quantity (consumption, regeneration), reactive power demand quantity (lag, lead), power factor demand value		
Voltage range		400 V AC		
		Total display area: 5V to 520 V (less than 5 V displays as 0 V)		
		Effective measurement range: 90 V to 520 V, peak: ±750V [OVER] indicates over-range warning		
Current ranges	Load current	CLAMP ON SENSOR 9660 : 5/10/50/100 A		
		CLAMP ON SENSOR 9661 : 5/10/50/100/500 A		
		CLAMP ON SENSOR 9669 : 100/200/1k A		
		CLAMP ON SENSOR 9694 : 500m/1/5/10/50 A		
		CLAMP ON SENSOR 9695-02 : 500m/1/5/10/50 A		
		CLAMP ON SENSOR 9695-03 : 5/10/50/100 A		
		AC FLEXIBLE CURRENT SENSOR CT9667-01, -02, -03 : 50/100/500 A (500A range)		
		AC FLEXIBLE CURRENT SENSOR CT9667-01, -02, -03 : 500/1k/5k A (5000A range)		
	Leakage current	LEAK CLAMP ON SENSOR 9675 : 50m/100m/500m/1/5 A		
		LEAK CLAMP ON SENSOR 9657-10 : 50m/100m/500m/1/5 A		
		Total display range: Within 0.4 to 130% of the range (zero is suppressed for less than 0.4%) Effective measurement range: Within 5 to 110% of the range [OVER] indicates over-range warning		
Power ranges		200.00 W to 6.0000 MW Depends on voltage/current combination and measured line type (see Measurement Range Configuration Tables)		
		Total display range: Within 0 to 130% of the range ("0W" display indicates zero rms voltage and/or current)		
		Effective measurement area: Within 5 to 130% of the range		
Measurement accuracy (50/60Hz)		Voltage : ±1.5% rdg. ±0.2% f.s. (combined accuracy with PW3365-20 + PW9020) Current : ±0.3% rdg. ±0.1% f.s. + clamp sensor accuracy Active power : ±2.0% rdg. ±0.3% f.s. + clamp sensor accuracy (power factor = 1)		
Calculations		RMS calculation/ fundamental wave calculation		
VT ratio settings	Any	0.01 to 9999.99	Selections	1/60/100/200/300/600/700/1000/2000/2500/5000
CT ratio settings	Any	0.01 to 9999.99	Selections	1/40/60/80/120/160/200/240/300/400/600/800/1200
Input methods				Voltage: Isolated inputs using Voltage Sensor PW9020 Current: Isolated input using a clamp-on sensor
Display update rate				Approx. 0.5 sec (except when accessing SD card or internal memory, or during LAN/USB communication)
Measurement method				Digital sampling and zero cross synchronization calculation method Sampling: 10.24 kHz (2048 points) Calculation processing 50 Hz: Continuous, gapless measurement at 10 cycles 60 Hz: Continuous, gapless measurement at 12 cycles
A/D converter resolution				16bit







*1 For individual clamp sensors' accuracy and combined accuracy figures, see pages 10 and 11.

Screen display		General	
List	Voltage, current, frequency, active/apparent/reactive power power factor, integrated power use, elapsed time	Product guarantee	One year
U/I	RMS value, fundamental wave value, waveform peak, phase angle	Display	3.5 inch TFT color LCD (320 × 240 pixel) Japanese, English, Chinese Backlight auto-off function (after 2 minutes) When AUTO OFF is active, the Power LED blinks
Power	Per-channel and total active power, apparent power, reactive power, power factor	Operating environment	Indoors, Pollution degree 2, altitude up to 2000 m (6562-ft.)
Integ	Active energy, reactive energy, recording start time recording stop time, elapsed time, energy cost	Operating temperature and humidity (no condensation)	-10°C to 50°C (14°F to 122°F), 80% RH or less During battery operation: 0°C to 40°C (32°F to 104°F), 80% RH or less During battery charging: 10°C to 40°C (50°F to 104°F), 80% RH or less
Demand	Active power demand value, reactive power demand value power factor demand value	Storage temperature and humidity (no condensation)	0°C to 60°C (32°F to 140°F), 80% RH or less However, the battery's storage temperature range is -10°C to 30°C (14°F to 86°F)
Waveform	Displays voltage and current waveform	Maximum rated voltage between terminals	Voltage input section : 1.7 VAC, 2.4 Vpeak Current input section : 1.7 VAC, 2.4 Vpeak
Zoom	Enlarged view of 4 user-selected parameters	Maximum rated voltage to earth	Voltage input section: 600V Measurement Category III 300V Measurement Category IV Current input section: Depends on clamp sensor in use.
Trend	For one selected measurement item displays maximum, average and minimum values	Dielectric strength	7.06 kVrms AC
Recording		Applicable standards	Safety: EN61010, EMC: EN61326, EN61000-3-2, EN61000-3-3
Save destination	SD Card, internal memory (capacity: approx. 320 KB)	Power supply	(1) Z1008 AC Adapter : 100 VAC to 240 VAC Maximum rated power : 45VA (including AC adapter) (2) Model 9459 Battery Pack : Ni-MH DC7.2 V 2700 mAh Continuous battery operation time Approx. 5 hr. Maximum rated power : 3VA
Save interval time	1/2/5/10/15/30 seconds, 1/2/5/10/15/20/30/60 minutes Available storage time is displayed on the PW3365-20's setting screen	Charge function	Charge time: Max. 6 hr. 10 min. (reference value at 23°C) Charges the battery regardless of whether the instrument is on or off
Save items	Measurement save : Average only/average, maximum, minimum Screen save : Saves the displayed screen as a BMP at a fixed interval*1 Waveform save : Stores binary waveform data*2	Backup battery life	Clock and settings (Lithium battery), Approx. 10 years @23°C (@73.4°F)
Recording start methods	Interval time, manual, or at specified time, repeat	Dimensions	Approx. 180W(7.09") × 100H(3.94") × 48D (1.89") mm (without PW9002) Approx. 180W(7.09") × 100H(3.94") × 68D (2.68") mm (with PW9002)
Recording stop methods	Manual, or at specified time (up to one year), timer	Mass	Approx. 540g (19 oz) (without PW9002), Approx. 820g (28.9 oz) (with PW9002)
*1 The minimum interval time for saving screen copies is 5 min. If the setting is less than 5 min., screen copies will be saved every 5 min.		Accessories	SAFETY VOLTAGE SENSOR PW9020 (1 set) AC ADAPTER Z1008 (1) USB cable (1) Instruction manual (1) Measurement guide (1) Color spiral tubes (1 set : red, yellow, blue/four each) Spiral tubes (10)
*2 With shortest interval of 1 minute. When set to less than 1 minute, waveforms are saved once every minute		External interfaces	
SD card	Settings data, measurement data, screen data, waveform data	LAN	
LAN	10BASE-T/100BASE-TX IEEE802.3 Compliance - HTTP server function	USB	
USB	USB Ver 2.0, Windows 8 (32/64bit)/Windows 7 (32/64bit) / Vista (32bit) / XP - When connected to a computer, the SD Card and internal memory are recognized as removable storage devices.	LAN/USB	
LAN/USB	Download settings and data using free application program		

POWER LOGGER VIEWER SF1001 Specifications

Functions		General Specifications	
Trend graph display function	Display items Voltage, current, active power, reactive power, apparent power, power factor, frequency, integrated active power, integrated reactive power, demand volume, demand value, voltage disequilibrium factor	Print function	Preview and print content shown on the trend graph, report, harmonic graph and settings displays.
	Stacked bar graph display : Up to 16 types of data series		Comment entry (Text comments can be entered in any printout)
	Cursor measurements Measurement values can be displayed by the cursor		Header/Footer settings: Sets the header and footer for each printout
Summary display function	Displayed items are the same as for the trend Graph Display	Report printing	Printing support Any color or monochrome printing supported by the operating system
	Daily, weekly and monthly report displays: Accumulates and displays daily, weekly and monthly reports over specified period.		Print (static) contents over a specific time period
	Load factor calculation display: Calculates and displays load factor and demand factor results with daily, weekly and monthly reports		Output contents: Standard or selected output items
Time span aggregation: Aggregates data into up to four specified time spans		Available output items: Trend graph, summary, daily report, waveform	Report creation method: Standard print
Waveform display	Displays waveform data at specified date and time	Report output settings: Save/load report output settings	
Copy function	Captures any display image to the clipboard	Supported models	PW3365-20 / PW3360-20 / PW3360-21 LR5000 series ; Data previously loaded by the LR5000 Utility (.hrp2 format) using a PC
		Supported computer operating systems	Windows 8 (32/64bit) Windows 7 SP1 or later (32/64bit) Windows Vista SP2 or later (32bit) Windows XP SP3 or later (32bit)

Current CLAMP

					
CLAMP ON SENSOR 9694	CLAMP ON SENSOR 9660	CLAMP ON SENSOR 9661	CLAMP ON SENSOR 9669	CLAMP ON SENSOR 9695-02	CLAMP ON SENSOR 9695-03
Cord length 3 m (9.84ft)	Cord length 3 m (9.84ft)	Cord length 3 m (9.84ft)	Cord length 3 m (9.84ft)	Connect with the 9695-02/-03, Output BNC terminal Cord length: 3 m (9.84ft)	CONNECTION CORD 9219
Measurable conductor diameter φ15mm (0.59")	Measurable conductor diameter φ15mm (0.59")	Measurable conductor diameter φ46mm (0.81")	Measurable conductor diameter φ55mm (2.17") 80 (3.15")×20 (0.79")mm	Measurable conductor diameter φ15mm (0.59")	Measurable conductor diameter φ15mm (0.59")
Primary current rating 5A AC	Primary current rating 100A AC	Primary current rating 500A AC	Primary current rating 1000A AC	Primary current rating 50A AC	Primary current rating 100A AC
Accuracy Amplitude (45 to 66 Hz) / Phase (45 Hz to 5 kHz) ±0.3% rdg.±0.02% f.s. Within ±2°	Accuracy Amplitude (45 to 66 Hz) / Phase (45 Hz to 5 kHz) ±0.3% rdg.±0.02% f.s. Within ±1°	Accuracy Amplitude (45 to 66 Hz) / Phase (45 Hz to 5 kHz) ±0.3% rdg.±0.01% f.s. Within ±0.5°	Accuracy Amplitude (45 to 66 Hz) / Phase (45 Hz to 5 kHz) ±1.0% rdg.±0.01% f.s. Within ±1°	Accuracy Amplitude (45 to 66 Hz) / Phase (45 Hz to 5 kHz) ±0.3% rdg.±0.02% f.s. Within ±2°	Accuracy Amplitude (45 to 66 Hz) / Phase (45 Hz to 5 kHz) ±0.3% rdg.±0.02% f.s. Within ±1°
Frequency characteristic 40Hz to 5kHz Within ±1.0%	Frequency characteristic 40Hz to 5kHz Within ±1.0%	Frequency characteristic 40Hz to 5kHz Within ±1.0%	Frequency characteristic 40Hz to 5kHz Within ±2.0%	Frequency characteristic 40Hz to 5kHz Within ±1.0%	Frequency characteristic 40Hz to 5kHz Within ±1.0%
Effect of external magnetic field with a magnetic field of 400 A/ m AC Equivalent to 0.1 A or less	Effect of external magnetic field with a magnetic field of 400 A/ m AC Equivalent to 0.1 A or less	Effect of external magnetic field with a magnetic field of 400 A/ m AC Equivalent to 0.1 A or less	Effect of external magnetic field with a magnetic field of 400 A/ m AC Equivalent to 1 A or less	Effect of external magnetic field with a magnetic field of 400 A/ m AC Equivalent to 0.1 A or less	Effect of external magnetic field with a magnetic field of 400 A/ m AC Equivalent to 0.1 A or less
Effect of conductor position Within ±0.5%	Effect of conductor position Within ±0.5%	Effect of conductor position Within ±0.5%	Effect of conductor position Within ±1.5%	Effect of conductor position Within ±0.5%	Effect of conductor position Within ±0.5%
Maximum rated voltage to earth CAT III 300V rms	Maximum rated voltage to earth CAT III 300V rms	Maximum rated voltage to earth CAT III 600V rms	Maximum rated voltage to earth CAT III 600V rms	Maximum rated voltage to earth CAT III 300V rms	Maximum rated voltage to earth CAT III 300V rms
Maximum input 45-66Hz 50A continuous	Maximum input 45-66Hz 130A continuous	Maximum input 45-66Hz 550A continuous	Maximum input 45-66Hz 1000A continuous	Maximum input 45-66Hz 60A continuous	Maximum input 45-66Hz 130A continuous
Dimensions / Mass 46W × 135H × 21D mm / 230g (1.81") × (5.31") × (0.83") / (8.1 oz)	Dimensions / Mass 46W × 135H × 21D mm / 230g (1.81") × (5.31") × (0.83") / (8.1 oz)	Dimensions / Mass 77W × 151H × 42D mm / 380g (3.03") × (5.94") × (1.65") / (13.4 oz)	Dimensions / Mass 99.5W × 188H × 42D mm / 590g (3.92") × (7.40") × (1.65") / (20.8 oz)	Dimensions / Mass 50.5W × 58H × 18.7D mm / 50g (2.28") × (2.28") × (0.74") / (1.8 oz)	Dimensions / Mass 50.5W × 58H × 18.7D mm / 50g (2.28") × (2.28") × (0.74") / (1.8 oz)

				
CT9667-01	CT9667-02	CT9667-03	CLAMP ON LEAK SENSOR 9657-10	CLAMP ON LEAK SENSOR 9675
Cord length : Sensor - circuit: 2 m (6.56ft) , Circuit - connector: 1 m (3.28ft)			Leakage Current Measurement Only Cord length : 3 m (9.84ft)	Leakage Current Measurement Only Cord length : 3 m (9.84ft)
Measurable conductor diameter	CT9667-01 : φ100mm, CT9667-02 : φ180mm CT9667-03 : φ254mm		Measurable conductor diameter φ40mm	Measurable conductor diameter φ30mm
Primary current rating	AC500A/ AC5000A (Switchable)		Primary current rating AC10A*	Primary current rating AC10A*
Accuracy 45-66Hz	±2.0% rdg ± 0.3% f.s. / Within ±1°		Accuracy ±1.0% rdg ±0.05% f.s. / Within ±3°	Accuracy ±1.0% rdg ±0.05% f.s. / Within ±5°
Frequency 10-20kHz	Within ± 3dB		Frequency 40 - 5kHz Within ± 5%	Frequency Within ± 5%
Effect of external magnetic field	1.5% / f.s. or less		Effect of external magnetic field 7.5mA max.	Effect of external magnetic field 7.5mA max.
Effect of conductor position	Within ± 3%		Effect of conductor position Within ±0.1%	Effect of conductor position Within ±0.1%
Maximum rated voltage to earth	CAT III 1000V rms / CAT IV 600V rms		Measurable conductor Insulated conductor	Measurable conductor Insulated conductor
Maximum input 45-66Hz	10000A continuous		Maximum input 45-66Hz 30A continuous	Maximum input 10A continuous
Dimensions / Mass	Circuit box: 35W×120.5H×34D CT9667-01, -02 : 280g, CT9667-03 : 470g		Dimensions / Mass 74W× 145H × 42D / 380g	Dimensions / Mass 60W× 112.5H × 23.6D / 160g
Power supply	LR06 alkaline battery × 2 or AC ADAPTER 9445-02/9445-03 (optional)		Not used for power measurements *Maximum AC measurement range with PW3365-20 is 5A	Not used for power measurements *Maximum AC measurement range with PW3365-20 is 5A
			Notes	

Measurement Range Configurations

CLAMP ON SENSOR 9694 / 9695-02 *1						
Voltage	Connection	Current				
		500.00mA	1.0000A	5.0000A	10.000A	50.000A
400.0V	1P2W	200.00W	400.00W	2.0000kW	4.0000kW	20.000kW
	1P3W 1P3W1U 3P3W2M 3P3W3M	400.00W	800.00W	4.0000kW	8.0000kW	40.000kW
	3P4W	600.00W	1.2000kW	6.0000kW	12.000kW	60.000kW

CLAMP ON SENSOR 9660 / 9695-03 / 9661 *2						
Voltage	Connection	Current				9661only 500.00A
		5.0000A	10.000A	50.000A	100.00A	
400.0V	1P2W	2.0000kW	4.0000kW	20.000kW	40.000kW	200.00kW
	1P3W 1P3W1U 3P3W2M 3P3W3M	4.0000kW	8.0000kW	40.000kW	80.000kW	400.00kW
	3P4W	6.0000kW	12.000kW	60.000kW	120.00kW	600.00kW

CLAMP ON SENSOR 9669				
Voltage	Connection	Current		
		100.00A	200.00A	1.0000kA
400.0V	1P2W	40.000kW	80.000kW	400.00kW
	1P3W 1P3W1U 3P3W2M 3P3W3M	80.000kW	160.00kW	800.00kW
	3P4W	120.00kW	240.00kW	1.2000MW

AC FLEXIBLE CURRENT SENSOR CT9667-01, -02, -03 (5kA)				
Voltage	Connection	Current		
		500.00A	1.0000kA	5.0000kA
400.0V	1P2W	200.00kW	400.00kW	2.0000MW
	1P3W 1P3W1U 3P3W2M 3P3W3M	400.00kW	800.00kW	4.0000MW
	3P4W	600.00kW	1.2000MW	6.0000MW

AC FLEXIBLE CURRENT SENSOR CT9667-01, -02, -03 (500A)				
Voltage	Connection	Current		
		50.00A	100.00A	500.00A
400.0V	1P2W	20.000kW	40.000kW	200.00kW
	1P3W 1P3W1U 3P3W2M 3P3W3M	40.000kW	80.000kW	400.00kW
	3P4W	60.000kW	120.00kW	600.00kW

Leak current: CLAMP ON LEAK SENSOR 9657-10, 9675	
Range	50.000mA / 100.00mA / 500.00mA / 1.0000A / 5.0000A

Combined Accuracy PW3365-20 + PW9020 + clamp sensors

Range	9694	9695-02
50.000A	-	±2.3% rdg. ±0.32% f.s.
10.000A	-	±2.3% rdg. ±0.4% f.s.
5.0000A	±2.3% rdg. ±0.32% f.s.	±2.3% rdg. ±0.5% f.s.
1.0000A	±2.3% rdg. ±0.4% f.s.	±2.3% rdg. ±1.3% f.s.
500.00mA	±2.3% rdg. ±0.5% f.s.	±2.3% rdg. ±2.3% f.s.

Range	9660, 9695-03	9661
500.00A	-	±2.3% rdg. ±0.31% f.s.
100.00A	±2.3% rdg. ±0.32% f.s.	±2.3% rdg. ±0.35% f.s.
50.000A	±2.3% rdg. ±0.34% f.s.	±2.3% rdg. ±0.4% f.s.
10.000A	±2.3% rdg. ±0.5% f.s.	±2.3% rdg. ±0.8% f.s.
5.0000A	±2.3% rdg. ±0.7% f.s.	±2.3% rdg. ±1.3% f.s.

Range	9669
1.0000kA	±3% rdg. ±0.31% f.s.
200.00A	±3% rdg. ±0.35% f.s.
100.00A	±3% rdg. ±0.4% f.s.

Range	CT9667-01, -02, -03 5.000kA range	CT9667-01, -02, -03 500A range
5.0000kA	±4% rdg. ±0.6% f.s.	-
1.0000kA	±4% rdg. ±1.8% f.s.	-
500.00A	±4% rdg. ±3.3% f.s.	±4% rdg. ±0.6% f.s.
100.00A	-	±4% rdg. ±1.8% f.s.
50.000A	-	±4% rdg. ±3.3% f.s.

Conditions of guaranteed accuracy: After 30 minute warm-up, with 50/60 Hz sine wave input voltage to earth 400V or less

Temperature and humidity for guaranteed accuracy: 23°C ±5°C (73 ± 9°F), 80%RH or less (applies to all specifications unless otherwise noted)

Display area of guaranteed accuracy: Effective measurement range

Period of guaranteed accuracy: Accuracy guaranteed for 1 year
Post-adjustment accuracy guaranteed for 6 months

Real-time clock accuracy: Within ±0.3 sec/day (with power on, within specified operating temperature and humidity ranges)

Temperature characteristic: Within ±0.1% f.s./ °C (except 23 ±5°C)

Effect of external magnetic field: Within ±1.5% f.s. (in a magnetic field of 400 A/m rms AC, 50/60 Hz)

Effect of radiated, radio-frequency, electromagnetic field: Within ±5% f.s. for voltage and active power at 10 V/m

Apparent power: ±1 dgt. for the calculation obtained from each measurement value

Reactive power: Fundamental waveform calculations
±2.0% rdg. ±3.0% f.s. + clamp-on sensor accuracy (w/power factor = 1)
Rms calculations
From each measurement applied to calculation ±1 dgt.

Energy: Active and reactive power measurement accuracies ±1 dgt.

Power factor: From each measurement applied to calculation ±1 dgt.

Frequency: ±0.5% rdg. (with 90 to 520 V sine wave input)

Demand value: Active and reactive power measurement accuracies ±1 dgt.

Demand quantity: Active and reactive power measurement accuracies ±1 dgt.

*1 For the 9694 sensor, the range of guaranteed accuracy is from 500 mA to 5 A, and for the 9695-02, from 500 mA to 50 A.

*2 For the 9660 and 9695-03 sensors, the range of guaranteed accuracy is from 5 A to 100 A and for the 9661, from 5 A to 500 A.

Current Display and Effective Measurement Ranges

typical

	Range	Total display range	Effective measurement range		Total display range	Effective peak
		Minimum	Minimum	Maximum	Maximum	Range
Voltage	400V Range	5.0V	90.0V	520.0V	520.0V	±750Vpeak
Current	5A Range	0.0200A	0.2500A	5.5000A	6.5000A	±20Apeak
	10A Range	0.040A	0.500A	11.000A	13.000A	±40Apeak
	50A Range	0.200A	2.500A	55.000A	65.000A	±200Apeak
	100A Range	0.40A	5.00A	110.00A	130.00A	±400Apeak
	500A Range	2.00A	25.00A	550.00A	650.00A	±1000Apeak

CLAMP ON POWER LOGGER

Order Code: **PW3365-20** (English model)

Accessories

SAFETY VOLTAGE SENSOR PW9020 (1 set) Instruction manual (1)
 AC ADAPTER Z1008 (1) Measurement guide (1)
 USB cable (1) Color spiral tubes (1 set : red, yellow, blue/four each)
 Spiral tubes (10)



Clamp On Power Logger PW3365-20 by itself does not support current and power measurements. Current and power measurements require clamp on sensors, sold separately. Use only HIOKI SD cards guaranteed to work for saving measurement data (options, sold separately).

Options

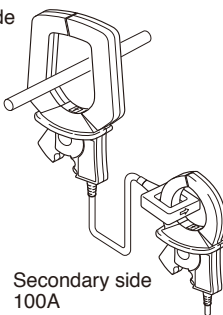
CLAMP ON SENSOR (for load current measurement)			CLAMP ON ADAPTER 9290-10	
CLAMP ON SENSOR	9694	(AC5A)	 CAT III 600V Cord length: 3m (9.84 ft)	 Primary side 1000A Secondary side 100A
CLAMP ON SENSOR	9660	(AC100A)		
CLAMP ON SENSOR	9661	(AC500A)		
CLAMP ON SENSOR	9669	(AC1000A)		
AC FLEXIBLE CURRENT SENSOR	CT9667-01	(AC500A/ 5000A)		
AC FLEXIBLE CURRENT SENSOR	CT9667-02	(AC500A/ 5000A)		
AC FLEXIBLE CURRENT SENSOR	CT9667-03	(AC500A/ 5000A)		
CLAMP ON SENSOR (Not CE marked) *	9695-02	(AC50A)		
CLAMP ON SENSOR (Not CE marked) *	9695-03	(AC100A)		
CONNECTION CORD	9219	(for connection to 9695-02, 9695-03)		

* When purchasing the 9695-02 and 9695-03, we recommend also purchasing the separately sold 9219 Connection Cord.

CLAMP ON LEAK SENSOR (for leakage current measurement)	
CLAMP ON LEAK SENSOR	9657-10
CLAMP ON LEAK SENSOR	9675

Measurable conductor diameter

φ55 mm (2.17in)
 Bus bar : 80 mm (3.46in) 5 20 mm (0.79 in)
 CT ratio : 10:1
 MAX. 1500A AC (continuous: 1000A)

POWER LOGGER VIEWER SF1001  Supported computer operating systems Windows 8 (32/64bit) Windows 7 SP1 or later (32/64bit) Windows Vista SP2 or later (32bit) Windows XP SP3 or later (32bit) Trend graph display function Summary display function Waveform display Print function Report printing	BATTERY SET PW9002  Battery Case and Battery Pack Set BATTERY PACK 9459 For purchase as replacement battery pack	SAFETY VOLTAGE SENSOR PW9020  PW3365-20 is bundled with 4 sensors Additional single sensors also available Cord length: 3m (9.84 ft)	CARRYING CASE C1005/C1008  <table border="0"> <tr> <td>C1005</td> <td>C1008</td> </tr> <tr> <td>Dimension : 390 W (15.4")</td> <td>390 W (15.4")</td> </tr> <tr> <td>(Approx) 275 H (10.8")</td> <td>275 H (10.8")</td> </tr> <tr> <td>110 D (4.3") mm</td> <td>150 D (5.9") mm</td> </tr> </table>	C1005	C1008	Dimension : 390 W (15.4")	390 W (15.4")	(Approx) 275 H (10.8")	275 H (10.8")	110 D (4.3") mm	150 D (5.9") mm
C1005	C1008										
Dimension : 390 W (15.4")	390 W (15.4")										
(Approx) 275 H (10.8")	275 H (10.8")										
110 D (4.3") mm	150 D (5.9") mm										
AC ADAPTER Z1008  Includes standard For separate purchase	SD MEMORY CARD 2GB Z4001  Stores up to one year's data when acquired at one minute intervals. Performance cannot be guaranteed on storage media other than Hioki-specified SD card options.	LAN CABLE 9642 									

Note: Company names and Product names appearing in this catalog are trademarks or registered trademarks of various companies.

HIOKI

HIOKI E. E. CORPORATION

HEADQUARTERS
 81 Koizumi, Ueda, Nagano, 386-1192, Japan
 TEL +81-268-28-0562 FAX +81-268-28-0568
<http://www.hioki.com> / E-mail: os-com@hioki.co.jp

HIOKI USA CORPORATION
 TEL +1-609-409-9109 FAX +1-609-409-9108
<http://www.hiokiusa.com> / E-mail: hioki@hiokiusa.com

HIOKI (Shanghai) SALES & TRADING CO., LTD.
 TEL +86-21-63910090 FAX +86-21-63910360
<http://www.hioki.cn> / E-mail: info@hioki.com.cn

HIOKI INDIA PRIVATE LIMITED
 TEL +91-124-6590210
 E-mail: hioki@hioki.in

HIOKI SINGAPORE PTE. LTD.
 TEL +65-6634-7677 FAX +65-6634-7477
 E-mail: info-sg@hioki.com.sg

HIOKI KOREA CO., LTD.
 TEL +82-2-2183-8847 FAX +82-2-2183-3360
 E-mail: info-kr@hioki.co.jp

DISTRIBUTED BY

(주)누비콤
 서울본사
 서울특별시 영등포구 경인로 775(문래동 3가, 에이스하이테크시티 3동 201호)
 TEL: 070-7872-0701 FAX: 02-2167-3801
 E-mail: sales@nubicom.co.kr
 고객지원센터
 TEL: 070-7872-0701, 080-801-7880 FAX: 02-2167-3802
 E-mail: otc@nubicom.co.kr
 대전 사무소
 대전광역시 유성구 대덕대로 593(도룡동 386-2) 대덕테크비즈니스센터 203호
 TEL: 070-7872-0712 FAX: 042-863-2023
 E-mail: inyeom@nubicom.co.kr