



DATA LOGGER LR5000 Series

Data Loggers 



Complete Line of Easy-to-Use Compact Loggers with Expanded Memory

The new HIOKI compact data logger series easily records temperature, voltage, current, and instrumentation signals over long periods. Carried over from its highly reputed predecessor, this series includes features and functions such as 7 times the recording capacity of former models, data import during recording, continuous measurement even during battery replacement, and intuitive PC software. Flexible and easy-to-use at single and multiple locations, the new HIOKI compact data logger series is ideal for any application that requires simple set-up but long-term, reliable recording capabilities.



ISO 9001
JMI-0216



ISO 14001
JQA-E-90091



www.hioki.com

HIOKI company overview, new products, environmental considerations and other information are available on our website.

Meet a Wide Variety of Data Logging Applications



Temperature Logger /Humidity Logger

Manage the temperature and humidity in offices and factories. Visually monitor the data to save on air-conditioning and heating costs.



Instrumentation Logger / Voltage Logger

Record fluid flow such as for water, gas and oil. Measure flow meter output signals to monitor flow trends.

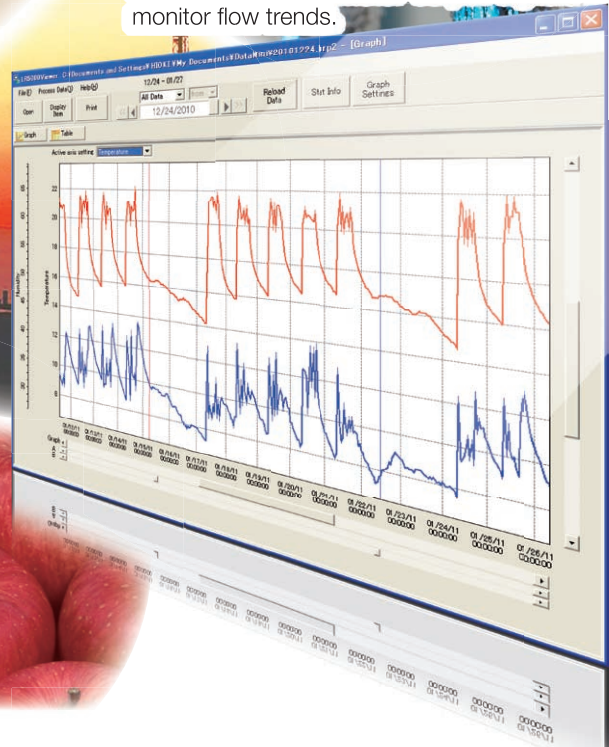

Clamp Logger

Manage the current consumption of plant and building equipment. Visually monitor power costs to efficiently conduct energy- and cost-saving activities.



Use as a Voltage Logger to record pyranometer output for evaluating insulation.

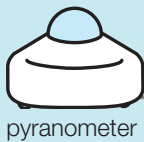

pyranometer



Voltage logger has a Preheat function

Use as a Clamp Logger and leakage sensor to record and monitor leakage trends.

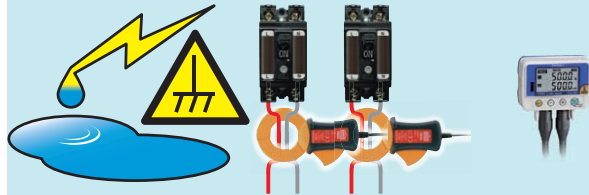

Use as a Temperature Logger to record warehouse temperatures for visually monitoring temperature changes of products and goods.



Use as an Instrumentation Logger to record pressure sensor output and monitor fluctuations in air or oil pressure.

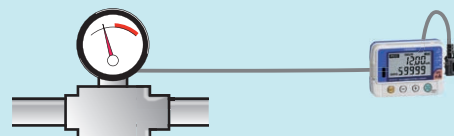

Easy operation in just 3 steps !



STEP 1

Set up & Record

Install a Data Logger, set an interval, and start measuring.

Easy to start recording



Set your recording interval. (from one second to 60 minutes)

Hold the REC button for two seconds to start recording.

Unlimited installation capabilities



Magnetic Strap (sold separately)

Wall-mounted Holder (sold separately) Not usable with LR5051

Kickstand (included, except for Model LR5051)



STEP 2

Transfer data from Data Logger to PC

Grab the Data Logger from the worksite and connect to a PC.

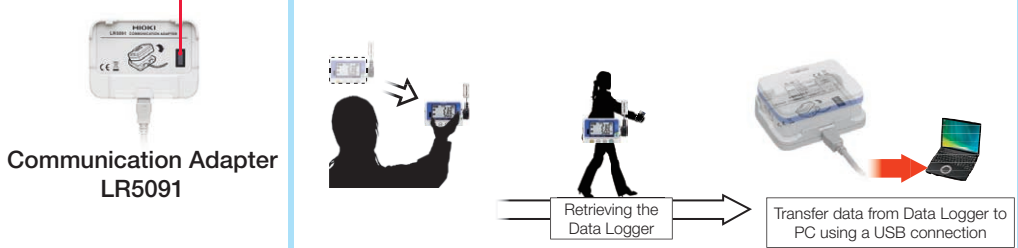

Download data using infrared communication.

Communication Adapter LR5091

Retrieving the Data Logger

Transfer data from Data Logger to PC using a USB connection

! Requires optional Communication Adapter or Data Collector

Using the Data Collector's internal memory, import data from up to 16 Data Loggers installed on site.*

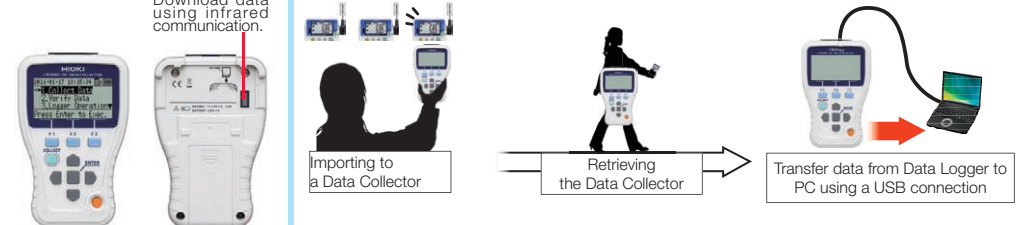

Download data using infrared communication.

Front Back

Data Collector LR5092-20

Importing to a Data Collector

Retrieving the Data Collector

Transfer data from Data Logger to PC using a USB connection

* Data for up to 16 channels can be stored. Combine up to 16 single-channel Data Loggers (Models LR5011, LR5031, LR5041, LR5042, and LR5043), or up to eight 2-channel Data Loggers (Models LR5001, and LR5051).

Top surface of LR5092-20

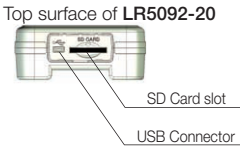

SD Card slot

USB Connector

Using an optional SD Memory Card, the amount of data that can be imported is practically limitless.

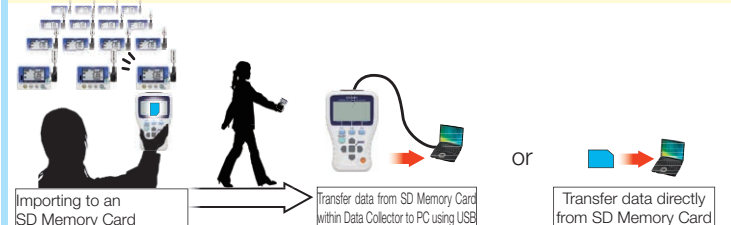

Importing to an SD Memory Card

Transfer data from SD Memory Card within Data Collector to PC using USB

or

Transfer data directly from SD Memory Card



STEP 3

View graphs and manage data

View data graphically and easily print using the bundled software.

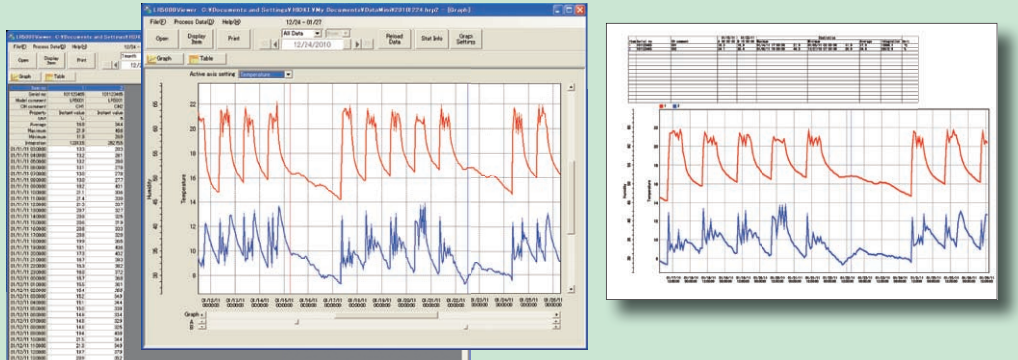

Advanced Features and Functions

Install Almost Anywhere

Easily mount the light-weight, pocket-sized loggers in tight spaces.



Actual size

Recording capacity up to 7 times previous models

Large internal memory stores 60,000 data points per channel. Long-term recording capability exceeds that of previous models.

Interval times	Instantaneous value	Statistical value
1s	16h 40m	-
2s	1d 9h 20m	8h 20m
5s	3d 11h 20m	20h 50m
10s	6d 22h 40m	1d 17h 40m
15s	10d 10h	2d 14h 30m
20s	13d 21h 20m	3d 11h 20m
30s	20d 20h	5d 5h
1m	41d 16h	10d 10h
2m	83d 8h	20d 20h
5m	208d 8h	52d 2h
10m	416d 16h	104d 4h
15m	625d	156d 6h
20m	833d 8h	208d 8h
30m	1250d	312d 12h
60m	2500d	625d

⚠ The maximum recording time depends on battery life. The battery may need to be replaced during long-term recording.

⚠ Customers using the previous Model 3636-20 Clamp Logger should note that the LR5051 can only record 15,000 points of average data, vs. 32,000 data points available in the 3636-20.

Easy-to-see dual display

Temperature and humidity or current channels can be displayed. View maximum and minimum values while measuring.

Moist environments

IP54 splash-proof rating withstands operation in extremely humid environments like kitchens and pipe rooms. (Except Model LR5051)



Record without missing fluctuations

With usual (instantaneous value) recording at long intervals, detailed fluctuations occurring within the intervals are missed. However, with the statistical value recording mode, detailed fluctuations are captured even when they occur during long recording intervals. In STAT mode, measurement is taken every second, and the maximum, minimum, average, and instantaneous values within the specified interval are recorded.

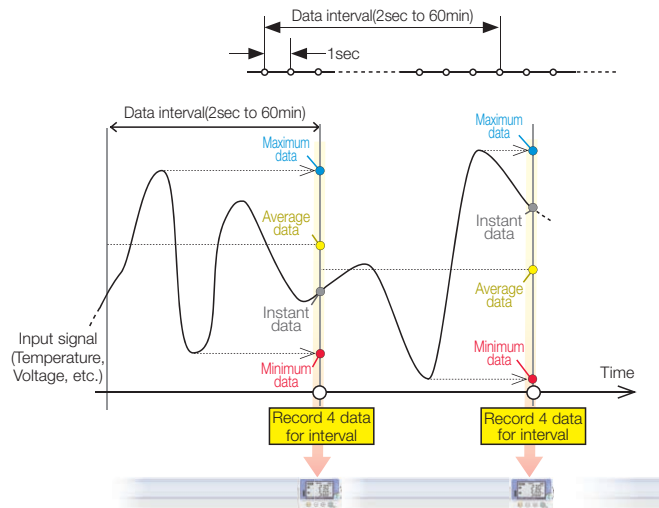

Transfer data even during recording

Continue to record even when transferring data.

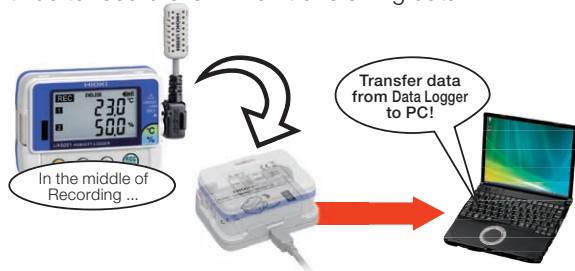

Batteries last up to 2 years

Energy-efficient design provides up to two years of battery life (For the LR5011 only. Actual battery life depends on model type and settings).



Never worry about a dead battery

The worry-free backup function preserves measurement data even after the battery dies.



Replace batteries while recording

Recording continues for about 30 seconds even with the battery removed.



Note. With the LR5001, recording is interrupted during battery replacement if the battery is very weak. After batteries are replaced, recording resumes automatically. Previously recorded data is not lost during battery replacement.

Never worry about operating errors

Worry-free backup preserves recorded data even if a new measurement is started by mistake.



Bundled Software Ensures Smooth and Easy Data Analysis

Import data to a PC and create graphs

Use the **LR5000 Utility** program to import Data Logger data to a PC to make graphs and analyze data further. Easily print results using your PC.

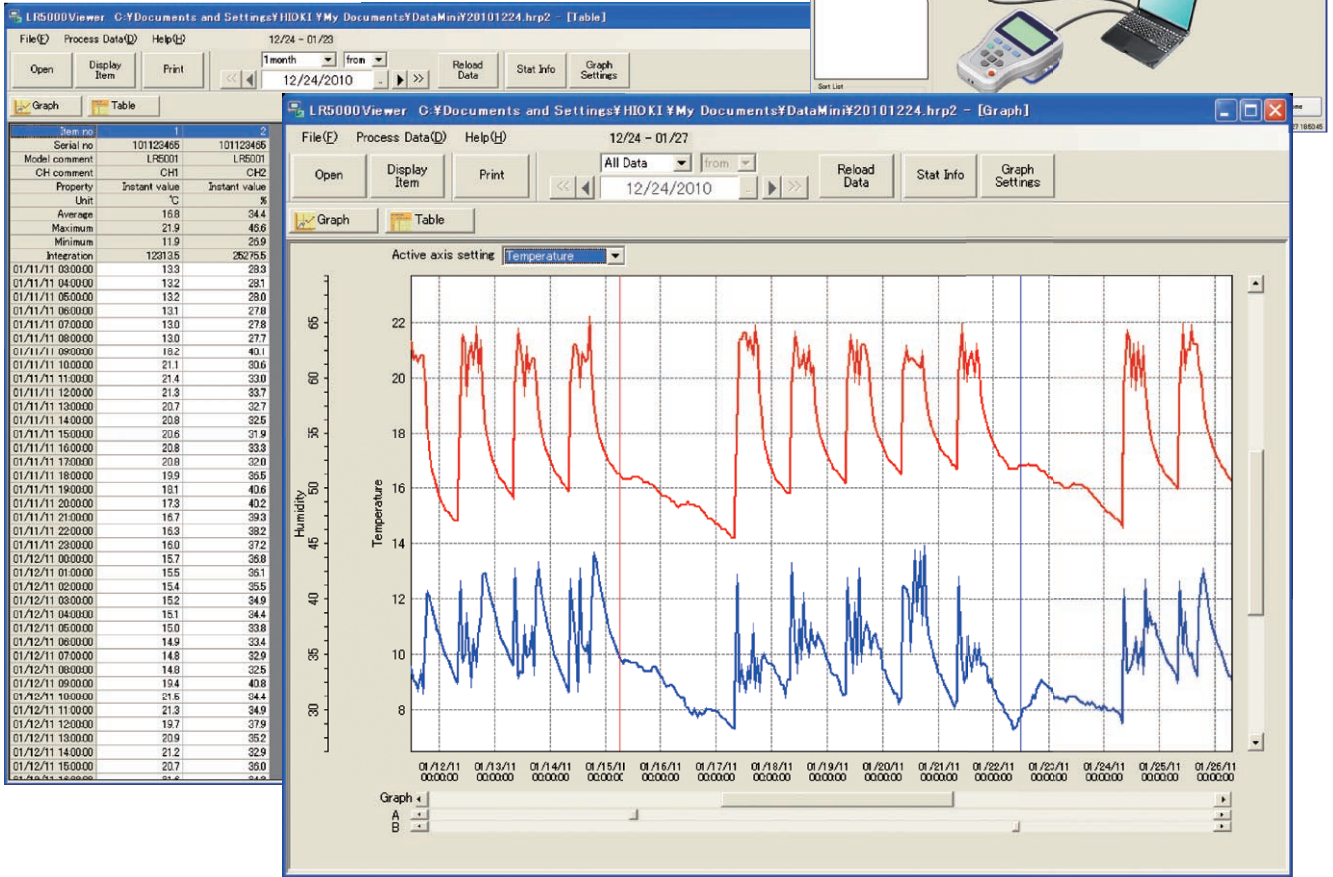

Show specific values using the cursor function

Use the A/B cursors to select any location on a graph and display its value. The PC software can also calculate maximum, minimum, and average values between A and B cursors.

Simple file aggregation and management

Transferred data can be combined with data previously transferred (from the same Data Logger unit) into one data on the PC.

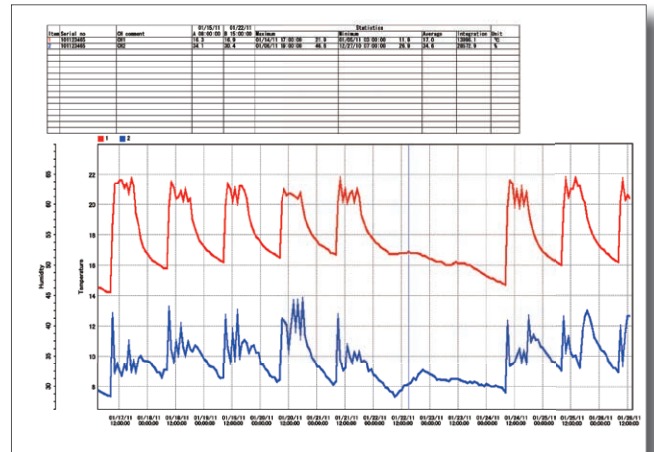
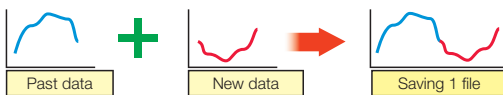

Display data from former Data Logger models



The PC application also supports data collected from the HIOKI 36XX Series Data Loggers.



LR5000 Utility Specifications	
Configuring Data Logger	<ul style="list-style-type: none"> • Import/export Data Logger settings (LR5091 or LR5092-20 required) • Settings sent to each LR5000 logger are also saved to the PC.
Graph display	<ul style="list-style-type: none"> • Graphically display data for up to 16 channels • Select colors and display/hide any channel and graph • Copy graph images to clipboard • Display statistical data (maximum, minimum and average) • Scaling function

Print function	<ul style="list-style-type: none"> • Print graphs • Print statistical data.
Data processing	<ul style="list-style-type: none"> • Scaling • Power calculation • Energy cost calculation • Operating ratio calculation • Integration • Dew point temperature • Calculate between channels
Operating environment	<ul style="list-style-type: none"> • OS: Windows XP (SP2 or later) / Windows Vista (SP1 or later) / Windows 7 • CPU : 1GHz or more • Memory : 512MB or more • Interface : USB • Free space in hard disk: 30MB or more

Communication Adapter and Data Collector Specifications (Product guaranteed for one year)

Physical appearance	 CE	 CE SD
Model	Communication Adapter LR5091	Data Collector LR5092-20
Features	<ul style="list-style-type: none"> •Transfer data from a Data logger to a PC •Transfer Data Logger configurations or clock settings from a PC to the Data Logger 	<ul style="list-style-type: none"> •Collect recorded data from the Data Logger to internal memory or SD card •View collected data in a graph •Transfer Data Logger configurations or clock settings from internal memory or SD card to the Data Logger •Transfer data from a Data Logger to a PC •Transfer Data Logger configurations or clock settings from a PC to the Data Logger
Interface with Data Logger	Infrared optical communications	
Interface with PC	USB2.0, Full Speed, Series Mini B Receptacle	
Clock functions	-	Auto calender, auto leap year
Display	-	Dot-matrix LCD (128 × 64 dots)
Display items	-	Data Logger configurations (Interval, Start/Stop method, Recording mode, Scaling, Alarm, Power-saving mode, Clock, Range) Collected data (Record list, Maximum data, Minimum data, Average, Graph, Value)
Internal memory capacity of data	-	60,000 data elements ×16ch (instantaneous value mode) 15,000 data elements ×16ch (statistical value mode)
Removable storage media	-	SD Card (SDHC, Max 32GB) Save data and configurations
Operating environment	Indoors	
Power supply	DC5V (USB bus power) Maximum rated power 0.5VA	DC3V (LR6 (AA) Alkaline battery 1.5V×2) or DC5V (USB bus power) Maximum rated power 1VA
Battery life	-	Approx. 12 hours or 500 times of data collection
Operating temperature and humidity	0°C(32°F) to 40°C(104°F) , 80%rh or less (non-condensating)	
Dimensions & Mass	Approx. 83mm(3.27 in)W×61mm(2.40in)H×19mm(0.75in)D 43g(1.5oz)	91mm(3.58in)W×141mm(5.55in)H×31mm(1.22in)D 215g(7.6oz) (excluding batteries)
Accessories	USB cable (1m)×1, CD (Application software "LR5000 Utility") × 1	Instruction manual ×1, Operation manual×1, LR6 (AA) Alkaline battery 1.5V×2, USB cable(1m)×1, CD (Application software "LR5000 Utility") × 1

LR5092-20 Option



SD Memory Card (2GB) Z4001

LR5000 Series Common specifications

(Product and accuracy guaranteed for one year)



Recording interval	1/ 2/ 5/ 10/ 15/ 20/ 30 seconds 1/ 2/ 5/ 10/ 15/ 20/ 30/ 60 minutes	Storage capacity	Instantaneous value mode 60,000 data sets per channel Statistical value mode 15,000 data sets per channel <small>Note: Customers using the previous Model 3636-20 Clamp Logger should note that the LR5051 can only record 15,000 points of average data, vs. 32,000 data points available in the 3636-20.</small>
Recording methods	One time recording Stop recording when the memory capacity is full. Endless recording Continue recording even when the memory capacity is full. (old data is overwritten.)	Display items	Measured value, Interval configuration, Date, Time, Alarm, Remaining battery power, Number of data, Maximum data, Minimum data
Recording modes (instantaneous value mode/statistical value mode)	Instantaneous recording Instantaneous values are recorded at every recording interval. Statistical value recording Measure at one second intervals, and record the instantaneous, maximum, minimum, and average values within every recording interval.	Recording start / stop	Recording start Manual start Timer start Recording stop Manual stop Timer stop When the memory capacity is full (One time recording)
		Data backup	Data from the last recording session is always backed up. Back up recorded data and configuration when battery is dead.
		Interface	Infrared optical communications with LR5091, LR5092-20
		Power supply	During battery replacement, recording and clock operations are preserved for about 30 seconds. (Recording operation continues if the battery is replaced within about 30 seconds.) <small>Note: With the LR5001, recording is interrupted during battery replacement if the battery is very weak. After batteries are replaced, recording resumes automatically. Previously recorded data is not lost during battery replacement.</small>

LR5000 Series common options



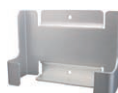

Magnetic Strap
Z5004



Wall-mounted Holder
LR9901
Not compatible with Model LR5051

Product Specifications (Product and accuracy guaranteed for one year) **See page 6 for Common specifications**

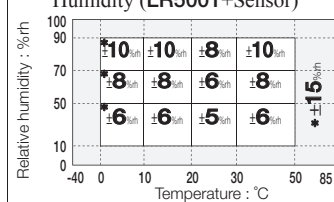
Physical appearance																								
Model	Humidity Logger LR5001	Temperature Logger LR5011																						
Features	Temperature and humidity are recorded simultaneously using supplied or optional temperature and humidity sensors.	Temperature measurement with external temperature sensor. Select the sensor according to the measurement object																						
Measurement items	Temperature 1ch and Humidity 1ch	Temperature 1ch																						
Measurement range	Temperature : -40°C to 85°C Humidity : 0% to 100%rh	-40.0°C to 180°C *Depends on measurement range of sensor.																						
Accuracy	<p>Temperature (LR5001 + Sensor)</p> <table border="1"> <tr><td>85</td><td>±2.0°C</td></tr> <tr><td>70</td><td>±1.0°C</td></tr> <tr><td>35</td><td>±0.5°C</td></tr> <tr><td>0</td><td>±1.0°C</td></tr> <tr><td>-40</td><td>±1.0°C</td></tr> </table> <p>Humidity (LR5001+Sensor)</p>  <p>(LR5011+Sensor)</p> <table border="1"> <tr><td>180</td><td>±5.0°C</td></tr> <tr><td>120</td><td>±2.0°C</td></tr> <tr><td>70</td><td>±1.0°C</td></tr> <tr><td>35</td><td>±0.5°C</td></tr> <tr><td>0</td><td>±1.0°C</td></tr> <tr><td>-40</td><td>±1.0°C</td></tr> </table>	85	±2.0°C	70	±1.0°C	35	±0.5°C	0	±1.0°C	-40	±1.0°C	180	±5.0°C	120	±2.0°C	70	±1.0°C	35	±0.5°C	0	±1.0°C	-40	±1.0°C	
85	±2.0°C																							
70	±1.0°C																							
35	±0.5°C																							
0	±1.0°C																							
-40	±1.0°C																							
180	±5.0°C																							
120	±2.0°C																							
70	±1.0°C																							
35	±0.5°C																							
0	±1.0°C																							
-40	±1.0°C																							
Waterproof and dustproof performance	IP54 (splash-proof construction)																							
Operating temperature and humidity	-20°C(-4°F) to 70°C(158°F) , 80%rh or less (non-condensating)																							
Dimensions & Mass	Approx. 79mm(3.11in)W×57mm(2.24in)H×28mm(1.10in)D 105g(3.7oz)																							
Power supply	LR6 (AA) Alkaline battery 1.5V×1																							
Accessories	Humidity sensor LR9504×1, Kickstand	Kickstand																						
	LR6 (AA) Alkaline battery 1.5V×1, Instruction manual ×1, Operation manual×1																							
Battery life	Case 1 : Approx. 3 months Case 2: Approx. 20 days	Case 1 : Approx. 2 years Case 2: Approx. 2 months																						
	Case 1 : 1min. recording interval, power-saving mode, Instantaneous recording, environmental temp.20°C Case 2 :1sec. recording interval, power-saving mode, Instantaneous recording, environmental temp.20°C																							

Analysis of measurement data on a PC requires the optional **LR5091 Communication Adapter** or **LR5092-20 Data Collector**. See page 6 for details.
(Reference) When the recording interval is set to 10 minutes, the **LR5001 Temperature and Humidity Logger** can measure for about one year between battery replacements.

LR5001 Options Humidity Sensor

■ **Humidity Sensor**

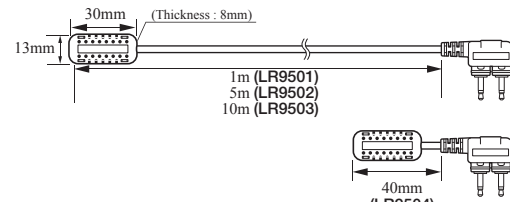

- Models (length) : LR9501 (1m)
LR9502 (5m)
LR9503 (10m)
LR9504 (40mm, bundled accessory)
- Temperature range : -40.0°C to 85.0°C
- Humidity range : 0.0%rh to 100.0%rh
- Response time : Approximately 300 seconds
(Temperature and humidity; 90% response time)

LR5011 Options Temperature Sensor

■ **Molded plastic type**

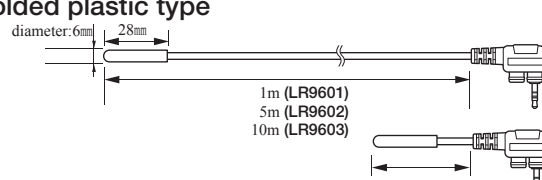

- Models (length) : LR9601 (1m) LR9602 (5m)
LR9603 (10m) LR9604 (45mm)
- Temperature range : -40°C to 180°C
- Response time : Approx. 100 seconds (90% response time)
- Material : Cable : Silicon Sensor head : Silicon

■ **Lug type**

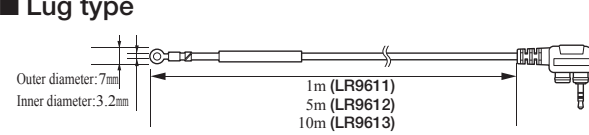

- Models(length) : LR9611 (1m) LR9612 (5m)
LR9613 (10m)
- Temperature range : -30°C to 180°C
- Response time : Approx. 45 seconds (90% response time)
- Material: Cable : Silicon Sensor head : Nickel-plated brass

■ **Sheathed type**

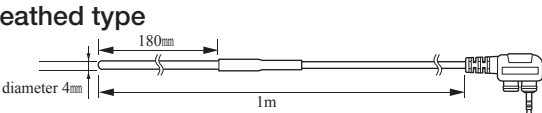

- Models(length) : LR9621(1m)
- Temperature range : -40°C to 120°C
- Response time : Approx. 90 seconds (90% response time)
- Material : Cable : Silicon Sensor head : SUS304

■ **Needle type**

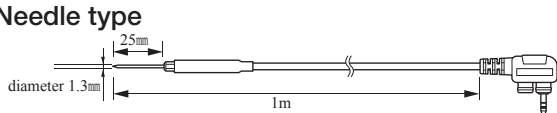

- Models(length) : LR9631(1m)
- Temperature range : -40°C to 120°C
- Response time : Approx. 20 seconds (90% response time)
- Material : Cable : Silicon Sensor head : SUS304

Product Specifications (Product and accuracy guaranteed for one year) **See page 6 for Common specifications**

Physical appearance		
Model	Instrumentation Logger LR5031	Voltage Logger LR5041, LR5042, LR5043
Features	For recording 4-20 mA instrumentation signals, etc.	For recording instrumentation signals and measuring analog outputs from sensors and other devices
Measurement items	For Instrumentation / 0 to 20mA DC, 1ch	DC voltage 1ch
Measurement range	DC -30.00 to 30.00mA	LR5041: -50.00mV to 50.00mV LR5042: -5.000V to 5.000V LR5043: -50.00V to 50.00V
Accuracy	±0.5%rdg. ±5dgt. (@23°C±5°C)	±0.5%rdg. ±5dgt. (@23°C±5°C)
Waterproof and dustproof performance	IP54 (splash-proof construction)	
Operating temperature and humidity	-20°C(-4°F) to 70°C(158°F), 80%rh or less (non-condensating)	
Dimensions & Mass	Approx. 79mm(3.11in)W×57mm(2.24in)H×28mm(1.10in)D, 105g(3.7oz)	
Power supply	LR6 (AA) Alkaline battery 1.5V×1	
Accessories	Connection Cable LR9801×1, Kickstand LR6 (AA) Alkaline battery 1.5V×1, Instruction manual ×1, Operation manual×1	Connection Cable LR9802×1, Kickstand LR6 (AA) Alkaline battery 1.5V×1, Instruction manual ×1, Operation manual×1
Battery life	Case 1 : Approx. 2 years Case 2: Approx. 2 months Case 1 : 1min. recording interval, power-saving mode, Instantaneous recording, environmental temp.20°C Case 2 : 1 sec. recording interval, power-saving mode, Instantaneous recording, environmental temp.20°C	
Other	Preheat function (When using preheat function, a separate external power supply is required.)	

Analysis of measurement data on a PC requires the optional LR5091 Communication Adapter or LR5092-20 Data Collector. See page 6 for details.

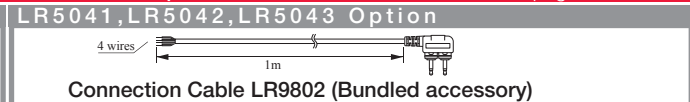
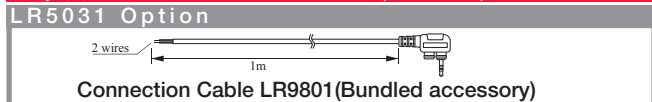

Product Specifications (Product and accuracy guaranteed for one year)
See page 6 for Common specifications

Physical appearance	
Model	Clamp Logger LR5051
Features	Recording load current of 50Hz/60Hz Recording leak current
Measurement items	AC Current (2 channels)
Measurement range	When Using 9669 : 1000A range When Using CT6500 : 50.00A / 500.0A range When Using 9695-02 : 5.000A / 50.00A range When Using 9675 : 500.0mA / 5.000A range When Using 9657-10 : 500.0mA / 5.000A range
Accuracy	±0.5%rdg. ±5dgt. +Clamp sensor accuracy
Waterproof and dustproof performance	Not waterproof
Operating temperature and humidity	-0°C(32°F) to 50°C(122°F), 80%rh or less (non-condensating)
Dimensions & Mass	Approx. 79mm(3.11in)W×70mm(2.76in)H×37mm(1.46in)D, 165g(5.8oz)
Power supply	LR6 (AA) Alkaline battery 1.5V × 2
Accessories	LR6 (AA) Alkaline battery 1.5V × 2 Instruction manual ×1, Operation manual×1
Battery life	Case 1 : Approx. 1 years Case 2: Approx. 1 months Case 1 : 1min. recording interval, power-saving mode, Instantaneous recording, environmental temp.20°C Case 2 : 1 sec. recording interval, power-saving mode, Instantaneous recording, environmental temp.20°C

Analysis of measurement data on a PC requires the optional LR5091 Communication Adapter or LR5092-20 Data Collector. See page 6 for details.

LR5051 Options

Physical appearance			
Model	Clamp on Sensor 9669	Clamp on Sensor CT6500	Clamp on Sensor 9695-02
Measurable conductor diameter	φ55 mm (2.17") or less, 80 (3.15")×20 (0.79") mm busbar	φ46 mm (1.81") or less	φ15 mm (0.59") or less
Primary current rating	1000A AC	500A AC	50A AC
Accuracy (45Hz to 66Hz)	±1.0%rdg. ±0.01%f.s.	±1.5%rdg. ±0.03%f.s.	±0.3%rdg. ±0.02%f.s.
Maximum rated voltage to earth	600Vrms (insulated conductor)	600Vrms (insulated conductor)	300Vrms (insulated conductor)
Maximum allowable input (45 to 66 Hz)	1000A continuous	600A continuous	60A continuous
Dimensions & Mass	99.5 (3.92")W × 188 (7.40")H × 42 (1.65")D mm, 590g (20.8 oz.)	77 (3.03")W × 151 (5.94")H × 42 (1.65")D mm, 360g (12.7 oz.)	51 (2.01")W × 58 (2.28")H × 19 (0.75")D mm, 50g (1.8 oz.)
Physical appearance			
Model	Clamp on Leak Sensor 9675	Clamp on Leak Sensor 9657-10	
Measurable conductor diameter	φ30mm	φ40mm	
Primary current rating	10A AC	10A AC	
Accuracy (45Hz to 66Hz)	±1.0%rdg.±0.005%f.s.	±1.0%rdg.±0.05%f.s.	
Lag current	1mA(When 10A AC is input)	5mA(When 100A AC is input)	
Maximum rated voltage to earth	300Vrms (insulated conductor)	300Vrms (insulated conductor)	
Maximum allowable input (45 to 66 Hz)	10A continuous	30A continuous	
Dimensions & Mass	60 (2.36")W × 113 (4.45")H × 24 (0.94")D mm, 160g (5.6 oz.)	74 (2.91")W × 145 (5.71")H × 42 (1.65")D mm, 380g (13.4 oz.)	

Note: Company names and Product names appearing in this catalog are trademarks or registered trademarks of various companies.



HIOKI E. E. CORPORATION

HEAD OFFICE :
81 Koizumi, Ueda, Nagano, 386-1192, Japan
TEL +81-268-28-0562 / FAX +81-268-28-0568
http://www.hioki.co.jp / E-mail: os-com@hioki.co.jp

HIOKI USA CORPORATION :
6 Corporate Drive, Cranbury, NJ 08512 USA
TEL +1-609-409-9109 / FAX +1-609-409-9108
http://www.hiokiusa.com / E-mail: hioki@hiokiusa.com

HIOKI (Shanghai) Sales & Trading Co., Ltd. :
1608-1610 Shanghai Times Square Office, 93 Huai Hai Zhong Road,
Shanghai, P.R.China POSTCODE: 200021
TEL +86-21-6391-0090/0092 FAX +86-21-6391-0360
http://www.hioki.cn / E-mail: info@hioki.com.cn
Beijing Office :TEL +86-10-5867-4080/4081
Guangzhou Office :TEL +86-20-38392673/2676
HIOKI SINGAPORE PTE.LTD. :
33 UBI AVENUE 3, #03-02 VERTEX, SINGAPORE 408868
TEL +65-6634-7677 FAX +65-6634-7477
E-mail: info@hioki.com.sg
HIOKI INDIA PRIVATE LIMITED :
Khandela House, 24 Gulmohar Colony Indore 452 018 (M.P.), India
TEL +91-731-4223901, 4223902 FAX +91-731-4223903
http://www.hioki.in / E-mail: info@hioki.in

DISTRIBUTED BY

<p>서울본사 서울특별시 영등포구 경인로 775(문래동 3가, 에이스하이테크리터 3동 201호) TEL: 070-7872-0701 FAX: 02-2167-3801 E-mail: sales@nubicom.co.kr</p> <p>고객지원센터 TEL: 070-7872-0701, 080-801-7880 FAX: 02-2167-3802 E-mail: oft@nubicom.co.kr</p> <p>대전 사무소 대전광역시 유성구 대덕대로 593(도룡동 386-2) 대덕테크비즈니스센터 203호 TEL: 070-7872-0712 FAX: 042-863-2023 E-mail: inyeom@nubicom.co.kr</p>	<p>(주)누비콤</p>
---	----------------------