

# BK PRECISION<sup>®</sup>

9800 Series

Programmable AC Power Source

Models: 9801, 9803, 9805

USER MANUAL



## Safety Summary

The following safety precautions apply to both operating and maintenance personnel and must be followed during all phases of operation, service, and repair of this instrument.

### **WARNING**

Before applying power to this instrument:

- Read and understand the safety and operational information in this manual.
- Apply all the listed safety precautions.
- Verify that the voltage selector at the line power cord input is set to the correct line voltage. Operating the instrument at an incorrect line voltage will void the warranty.
- Make all connections to the instrument before applying power.
- Do not operate the instrument in ways not specified by this manual or by B&K Precision.

Failure to comply with these precautions or with warnings elsewhere in this manual violates the safety standards of design, manufacture, and intended use of the instrument. B&K Precision assumes no liability for a customer's failure to comply with these requirements.

### ***Category rating***

The IEC 61010 standard defines safety category ratings that specify the amount of electrical energy available and the voltage impulses that may occur on electrical conductors associated with these category ratings. The category rating is a Roman numeral of I, II, III, or IV. This rating is also accompanied by a maximum voltage of the circuit to be tested, which defines the voltage impulses expected and required insulation clearances. These categories are:

Category I (CAT I): Measurement instruments whose measurement inputs are not intended to be connected to the mains supply. The voltages in the environment are typically derived from a limited-energy transformer or a battery.

Category II (CAT II): Measurement instruments whose measurement inputs are meant to be connected to the mains supply at a standard wall outlet or similar sources. Example measurement environments are portable tools and household appliances.

Category III (CAT III): Measurement instruments whose measurement inputs are meant to be connected to the mains installation of a building. Examples are measurements inside a building's circuit breaker panel or the wiring of permanently-installed motors.

Category IV (CAT IV): Measurement instruments whose measurement inputs are meant to be connected to the primary power entering a building or other outdoor wiring.

## **WARNING**

Do not use this instrument in an electrical environment with a higher category rating than what is specified in this manual for this instrument.

## **WARNING**

You must ensure that each accessory you use with this instrument has a category rating equal to or higher than the instrument's category rating to maintain the instrument's category rating. Failure to do so will lower the category rating of the measuring system.

### ***Electrical Power***

This instrument is intended to be powered from a CATEGORY II mains power environment. The mains power should be 110 V RMS or 220 V RMS. Use only the power cord supplied with the instrument and ensure it is appropriate for your country of use.

### ***Ground the Instrument***

## **WARNING**

To minimize shock hazard, the instrument chassis and cabinet must be connected to an electrical safety ground. This instrument is grounded through the ground conductor of the supplied, three-conductor AC line power cable. The power cable must be plugged into an approved three-conductor electrical outlet. The power jack and mating plug of the power cable meet IEC safety standards.

## **WARNING**

Do not alter or defeat the ground connection. Without the safety ground connection, all accessible conductive parts (including control knobs) may provide an electric shock. Failure to use a properly-grounded approved outlet and the recommended three-conductor AC line power cable may result in injury or death.

## **WARNING**

Unless otherwise stated, a ground connection on the instrument's front or rear panel is for a reference of potential only and is not to be used as a safety ground.

***Do not operate in an explosive or flammable atmosphere***

**! WARNING**

Do not operate the instrument in the presence of flammable gases or vapors, fumes, or finely-divided particulates.

**! WARNING**

The instrument is designed to be used in office-type indoor environments. Do not operate the instrument

- In the presence of noxious, corrosive, or flammable fumes, gases, vapors, chemicals, or finely-divided particulates.
- In relative humidity conditions outside the instrument's specifications.
- In environments where there is a danger of any liquid being spilled on the instrument or where any liquid can condense on the instrument.
- In air temperatures exceeding the specified operating temperatures.
- In atmospheric pressures outside the specified altitude limits or where the surrounding gas is not air.
- In environments with restricted cooling air flow, even if the air temperatures are within specifications.
- In direct sunlight.

**! CAUTION**

This instrument is intended to be used in an indoor pollution degree 2 environment. The operating temperature range is 0 °C to 40 °C and the operating humidity range is up to 80% relative humidity with no condensation allowed.

Measurements made by this instrument may be outside specifications if the instrument is used in non-office-type environments. Such environments may include rapid temperature or humidity changes, sunlight, vibration and/or mechanical shocks, acoustic noise, electrical noise, strong electric fields, or strong magnetic fields.

***Do not operate instrument if damaged***

**! WARNING**

If the instrument is damaged, appears to be damaged, or if any liquid, chemical, or other material gets on or inside the instrument, remove the instrument's power cord, remove the instrument from service, label it as not to be operated, and return the instrument to B&K Precision for repair. Notify B&K Precision of the nature of any contamination of the instrument.

*Clean the instrument only as instructed*

**⚠ WARNING**

Do not clean the instrument, its switches, or its terminals with contact cleaners, abrasives, lubricants, solvents, acids/bases, or other such chemicals. Clean the instrument only with a clean dry lint-free cloth or as instructed in this manual.

*Not for critical applications*

**⚠ WARNING**

This instrument is not authorized for use in contact with the human body or for use as a component in a life-support device or system.

*Do not touch live circuits*

**⚠ WARNING**

Instrument covers must not be removed by operating personnel. Component replacement and internal adjustments must be made by qualified service-trained maintenance personnel who are aware of the hazards involved when the instrument's covers and shields are removed. Under certain conditions, even with the power cord removed, dangerous voltages may exist when the covers are removed. To avoid injuries, always disconnect the power cord from the instrument, disconnect all other connections (for example, test leads, computer interface cables, etc.), discharge all circuits, and verify there are no hazardous voltages present on any conductors by measurements with a properly-operating voltage-sensing device before touching any internal parts. Verify the voltage-sensing device is working properly before and after making the measurements by testing with known-operating voltage sources and test for both DC and AC voltages. Do not attempt any service or adjustment unless another person capable of rendering first aid and resuscitation is present. Do not insert any object into an instrument's ventilation openings or other openings.

**⚠ WARNING**

Hazardous voltages may be present in unexpected locations in circuitry being tested when a fault condition in the circuit exists.

### *Fuse replacement*

#### **WARNING**

Fuse replacement must be done by qualified service-trained maintenance personnel who are aware of the instrument's fuse requirements and safe replacement procedures. Disconnect the instrument from the power line before replacing fuses. Replace fuses only with new fuses of the fuse types, voltage ratings, and current ratings specified in this manual or on the back of the instrument. Failure to do so may damage the instrument, lead to a safety hazard, or cause a fire. Failure to use the specified fuses will void the warranty.

### *Servicing*

#### **CAUTION**

Do not substitute parts that are not approved by B&K Precision or modify this instrument. Return the instrument to B&K Precision for service and repair to ensure that safety and performance features are maintained.

### *Cooling fans*

#### **CAUTION**

This instrument contains one or more cooling fans. For continued safe operation of the instrument, the air inlet and exhaust openings for these fans must not be blocked nor must accumulated dust or other debris be allowed to reduce air flow. Maintain at least 25 mm clearance around the sides of the instrument that contain air inlet and exhaust ports. If mounted in a rack, position power devices in the rack above the instrument to minimize instrument heating while rack mounted. Do not continue to operate the instrument if you cannot verify the fan is operating (note some fans may have intermittent duty cycles). Do not insert any object into the fan's inlet or outlet.

### *Use correctly sized wires*

#### **WARNING**

To connect a load to the power supply, use a wire diameter large enough to handle the maximum continuous output short-circuit current of the power supply without the wire overheating.

***For continued safe use of the instrument***

- Do not place heavy objects on the instrument.
- Do not obstruct cooling air flow to the instrument.
- Do not place a hot soldering iron on the instrument.
- Do not pull the instrument with the power cord, connected probe, or connected test lead.
- Do not move the instrument when a probe is connected to a circuit being tested.

## Compliance Statements

Disposal of Old Electrical & Electronic Equipment (Applicable in the European Union and other European countries with separate collection systems)



This product is subject to Directive 2002/96/EC of the European Parliament and the Council of the European Union on waste electrical and electronic equipment (WEEE), and in jurisdictions adopting that Directive, is marked as being put on the market after August 13, 2005, and should not be disposed of as unsorted municipal waste. Please utilize your local WEEE collection facilities in the disposition of this product and otherwise observe all applicable requirements.



# CE Declaration of Conformity

The power supply meets the requirements of 2006/95/EC Low Voltage Directive and 2004/108/EC Electromagnetic Compatibility Directive with the following standards.













## Low Voltage Directive

- EN61010-1: 2001

## EMC Directive

- EN 61000-3-2: 2006
- EN 61000-3-3: 1995+A1: 2001+A2: 2005
- EN 61000-4-2 / -3 / -4 / -5 / -6 / -11
- EN 61326-1: 2006

## Safety Symbols

	Refer to the user manual for warning information to avoid hazard or personal injury and prevent damage to instrument.
	Electric Shock hazard
	On (Supply). This is the AC mains connect/disconnect switch on the front of the instrument.
	Off (Supply). This is the AC mains connect/disconnect switch on the front of the instrument.
	DC current
	Alternating current
	Fuse Symbol
	Chassis (earth ground) symbol
	Ground terminal
	Protective earth ground
	CAUTION indicates a hazardous situation which, if not avoided, will result in minor or moderate injury
	WARNING indicates a hazardous situation which, if not avoided, could result in death or serious injury
	DANGER indicates a hazardous situation which, if not avoided, will result in death or serious injury.

# Table of Contents

<b>Safety Summary</b> .....	<b>i</b>
Compliance Statements .....	vii
Safety Symbols .....	ix
<b>1 General Information</b> .....	<b>1</b>
1.1 Product Overview .....	1
1.2 Package Contents .....	1
1.3 Product Dimensions .....	2
1.4 Front Panel Overview .....	5
<i>Front Panel Description</i> .....	5
1.5 Rear Panel Overview .....	7
1.6 Display Overview .....	8
<i>Display Description</i> .....	8
<b>2 Getting Started</b> .....	<b>10</b>
2.1 Input Power and Fuse Requirements .....	10
<i>Input Power</i> .....	10
<i>Fuse Requirements</i> .....	12
<i>Fuse Replacement</i> .....	13
2.2 Input Connections .....	15
2.3 Output Connections .....	17
2.4 Preliminary Check.....	20
<i>Self-test Errors</i> .....	21
<i>Output Check</i> .....	21
<i>Check Model and Firmware Version</i> .....	22
<b>3 Front Panel Operation</b> .....	<b>23</b>
3.1 Menu Options.....	23
<i>How to Access the Menu</i> .....	23
3.2 Configure Voltage and Frequency Output.....	24
<i>Setting Voltage</i> .....	24
<i>Output Range</i> .....	25
<i>Setting Frequency</i> .....	25

<i>Setting Phase Angle</i> .....	25
3.3 SYSTEM Menu .....	26
<i>Restore Factory Default Settings</i> .....	26
<i>Configure Power-On Settings</i> .....	28
<i>Configure Power-Out State</i> .....	28
<i>Enable/Disable Key Sound</i> .....	28
<i>Configure Trigger Source</i> .....	29
<i>Communication Setup</i> .....	29
<i>Save/Recall Instrument Settings</i> .....	31
3.4 CONFIG Menu.....	32
<i>Voltage Limits</i> .....	32
<i>Frequency Limits</i> .....	33
<i>Current Protection</i> .....	34
<i>External BNC</i> .....	34
3.5 Dimmer Output Simulation .....	36
3.6 List Mode.....	37
<i>Configure List Setting</i> .....	38
<i>Edit List File</i> .....	39
<i>Recall and Run Program</i> .....	41
<i>Power Line Disturbance Simulation (PLD)</i> .....	42
3.7 Sweep Mode.....	43
<i>Edit Sweep File</i> .....	44
<i>Recall and Run Sweep</i> .....	45
3.8 Measured Power Output and Settings Display .....	46
3.9 Key Lock.....	46
<b>4 Remote Operation.....</b>	<b>46</b>
4.1 Interface Connection .....	46
<i>RS-232</i> .....	47
<i>USBTMC</i> .....	47
<i>LAN</i> .....	47
<i>GPIB</i> .....	47
4.2 Remote Commands .....	48

<b>5</b>	<b>Troubleshooting Guide .....</b>	<b>48</b>
	<i>General.....</i>	<i>48</i>
	<i>Remote Control .....</i>	<i>49</i>
<b>6</b>	<b>Specifications .....</b>	<b>50</b>
	Calibration.....	51
	<b>SERVICE INFORMATION.....</b>	<b>52</b>
	<b>LIMITED TWO-YEAR WARRANTY .....</b>	<b>53</b>

# 1 General Information

## 1.1 Product Overview

The B&K Precision 9800 series are high performance AC power sources with the capability of producing up to 300 VAC at maximum power output of 300 VA, 750 VA or 1500 VA (depending on the model). These instruments are equipped with powerful features such as list mode, sweep mode, power line disturbance (PLD) simulation, and dimmer output simulation. Other features include an easy-to-read VFD display, user-friendly controls and a numeric keypad that allows for easy configurations from the front panel. Standard USB, RS232, LAN, and GPIB (models 9803 and 9805 only) interfaces are available to provide flexibility for remote operation.

### Features:

- High accuracy and resolution
- Programmable output voltage (0 – 300V) and frequency (45 Hz – 500 Hz)
- Standard USBTMC, RS232, LAN, and GPIB(model 9803 and 9805 only)
- Power line disturbance simulation
- Dimmer output simulation
- Adjustable output phase
- Frequency and voltage sweep function
- List mode to generate surge, sag and other line disturbance simulations
- OVP, OPP, OCP, and OTP protection features

## 1.2 Package Contents

Please inspect the instrument mechanically and electrically upon receiving it. Unpack all items from the shipping carton, and check for any obvious signs of physical damage that may have occurred during transportation. Report any damage to the shipping agent immediately. Save the original packing carton for possible future reshipment. Every power supply is shipped with the following contents:

- **1 x 9801/9803/9805 AC Power Source**
- **1 x User Manual**
- **1 x AC Power Cord (9801) or 1x AC Power Cord Unterminated (9803 & 9805)**
- **1 x Certificate of Calibration**
- **1 x Test Report**
- **1 x Rackmount ears with handles (9803 & 9805)**

Verify that all items above are included in the shipping container. If anything is missing, please contact B&K Precision.

## 1.3 Product Dimensions

### 9801

The 9801 power supply is designed to fit in a standard 19-inch half rackmount (optional IT-E151 rackmount kit) and is of 2U size.

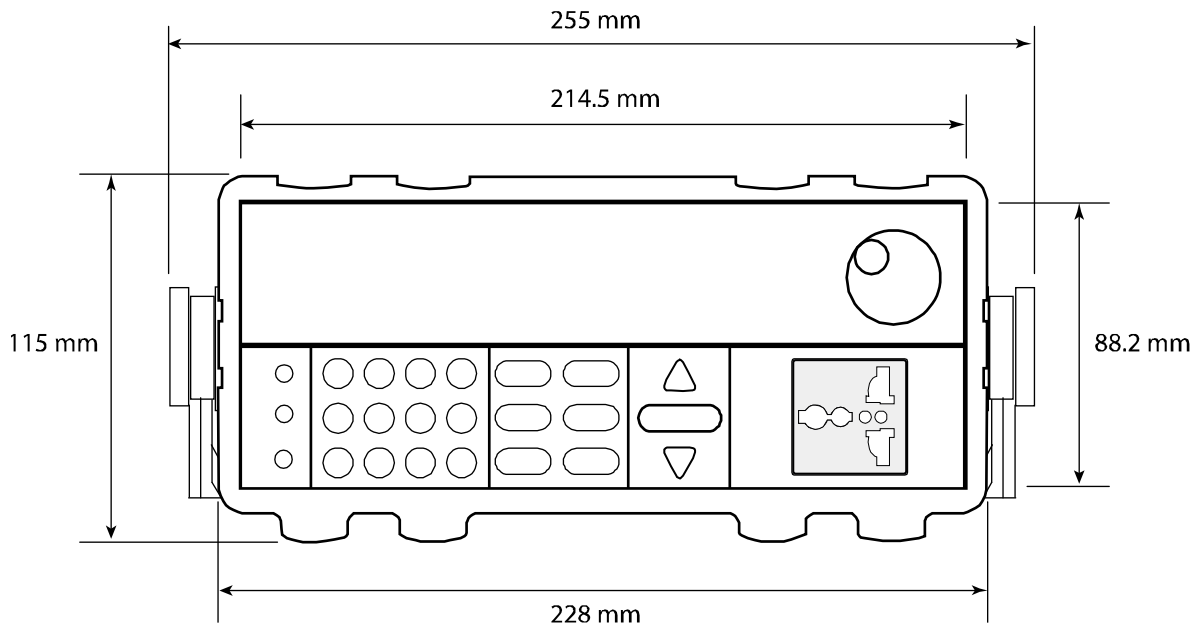

Figure 1 – Front Panel View

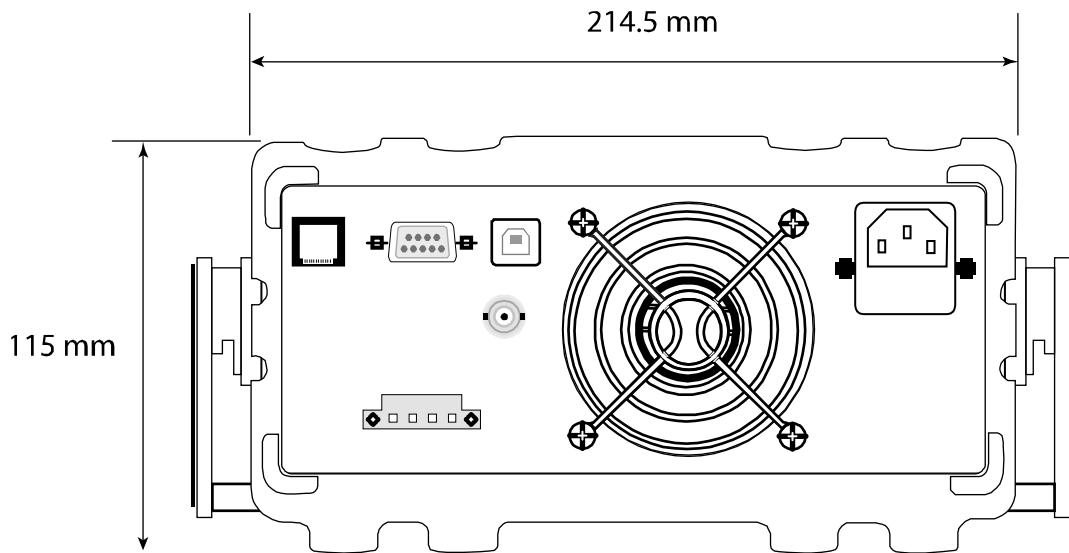

Figure 2 - Rear Panel View

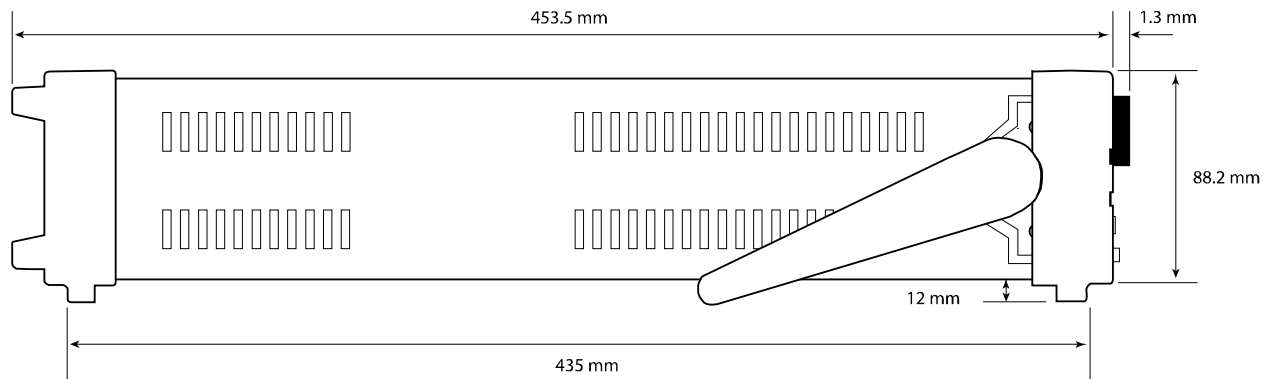

Figure 3 – Side View

## 9803 and 9805

The 9803 and 9805 power supplies are designed to fit into a standard 19-inch rackmount and is of 3U size.

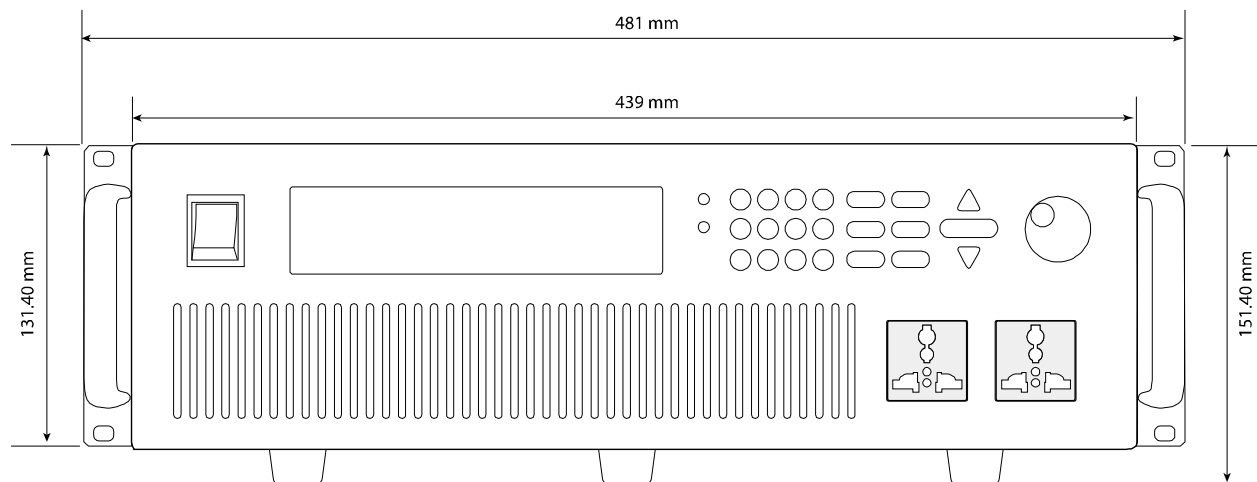
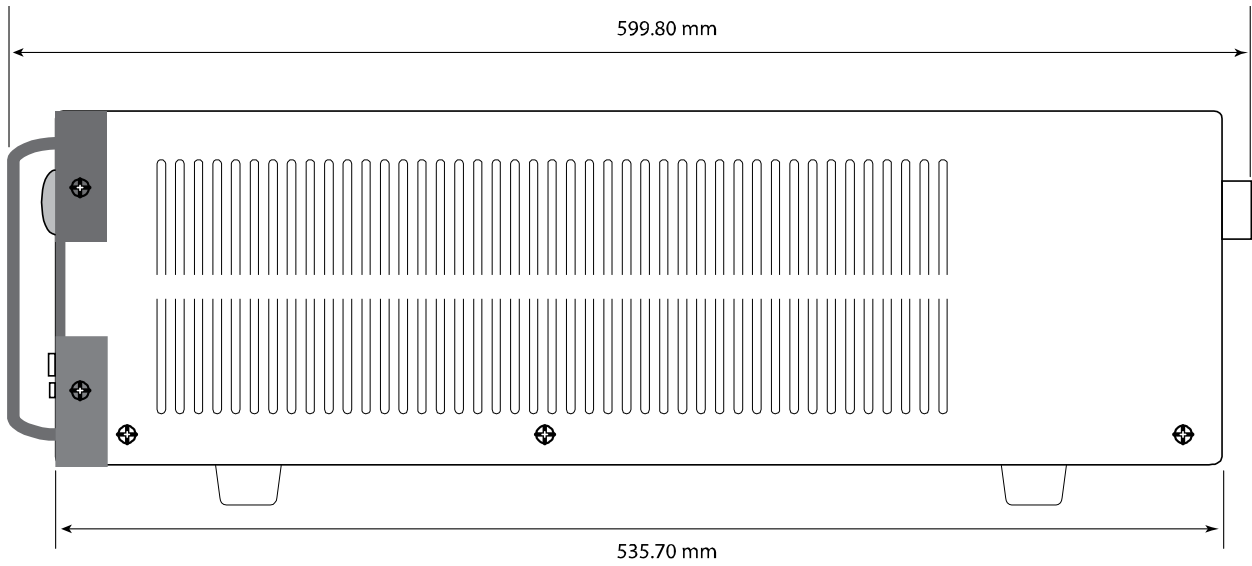

Figure 4 – Front View





**Figure 5 - Side View**

## 1.4 Front Panel Overview

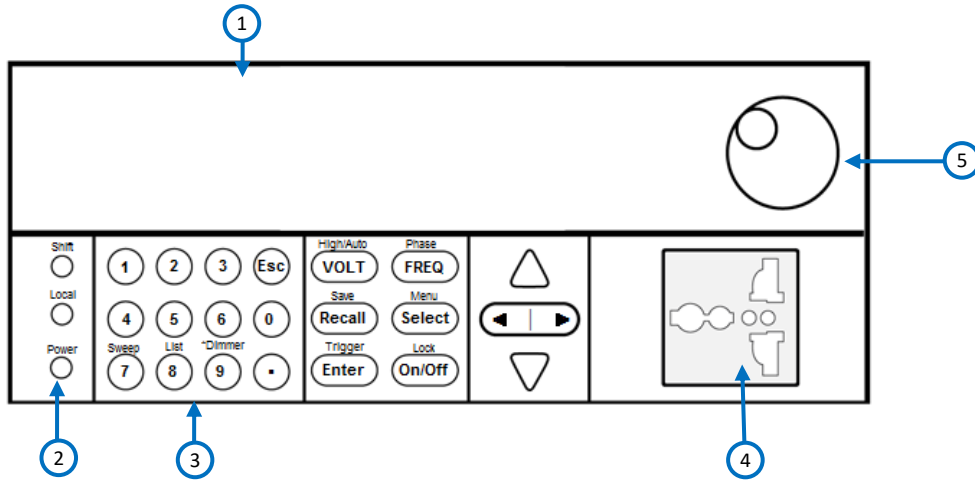

Figure 6 – Front Panel 9801

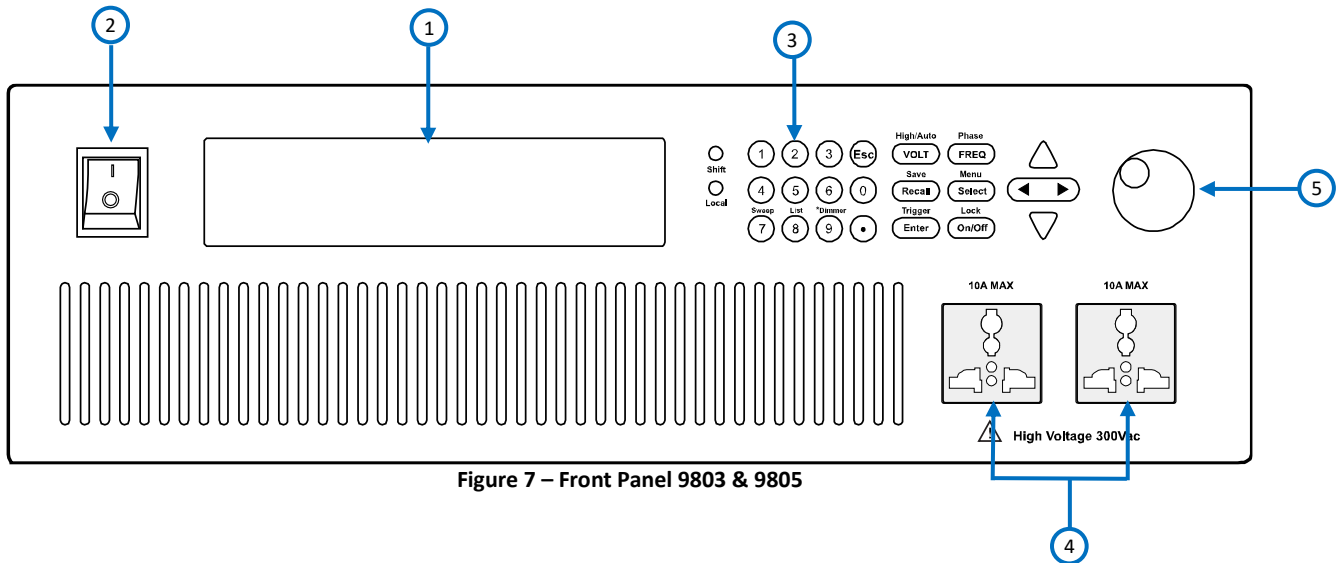

Figure 7 – Front Panel 9803 & 9805

### Front Panel Description

- |   |  |
|---|--|
| ① | <b>VFD display</b>   |
| ② | <b>Power On/Off switch</b>   |
| ③ | <b>Numeric keypad</b><br>7: Sweep – Configure and enable the sweep function settings<br>8: List – Configure and enable the list function |

---

9: \*Dimmer – Configure the dimmer output simulation settings

---

4

**AC output socket(s)**

---

5

**Rotary knob**

---



**Local button**

*Set the instrument back to local mode.*

---



**Shift button**

*Enables access to secondary functions of some buttons.*

---



**Esc button**

*Used to exit menu settings.*

---

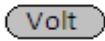

**VOLT / High / Auto button**

*Set the output voltage or range between high and auto.*

---

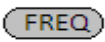

**FREQ / Phase button**

*Set the output frequency or phase*

---



**Recall / Save button**

*Used to save or recall instrument settings.*

---

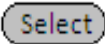

**Select / Menu button**

*Toggles between output power (in Watts)/power factor (PF) or output power (in Volt-ampere)/peak current (Apk) display or access the main menu.*

---

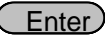

**Enter / Trigger button**

*Used to confirm setting/parameter changes or to send a trigger manually.*

---

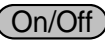

**On/Off / Lock button**

*Controls the output state or locks the front panel button.*

---

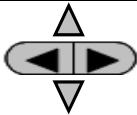

**Navigation arrow keys**

---

## 1.5 Rear Panel Overview

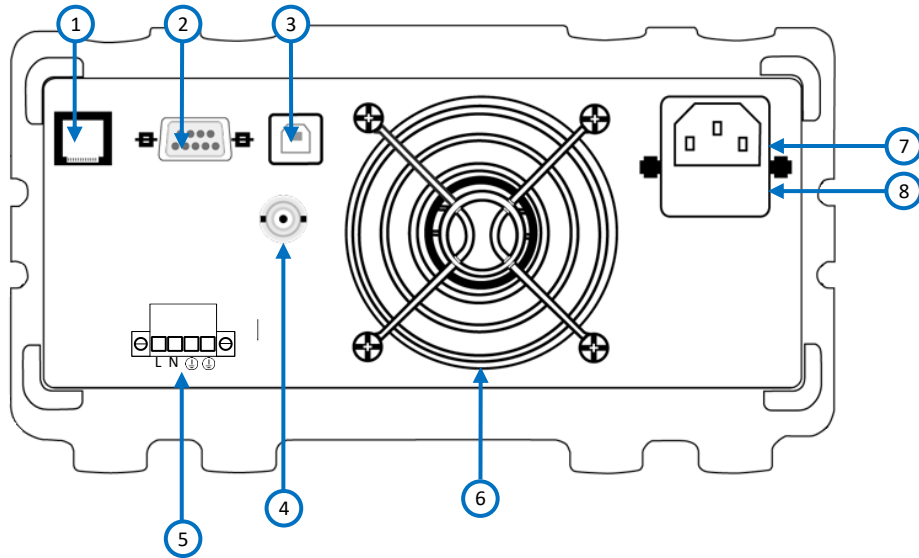

Figure 8 - Rear Panel 9801

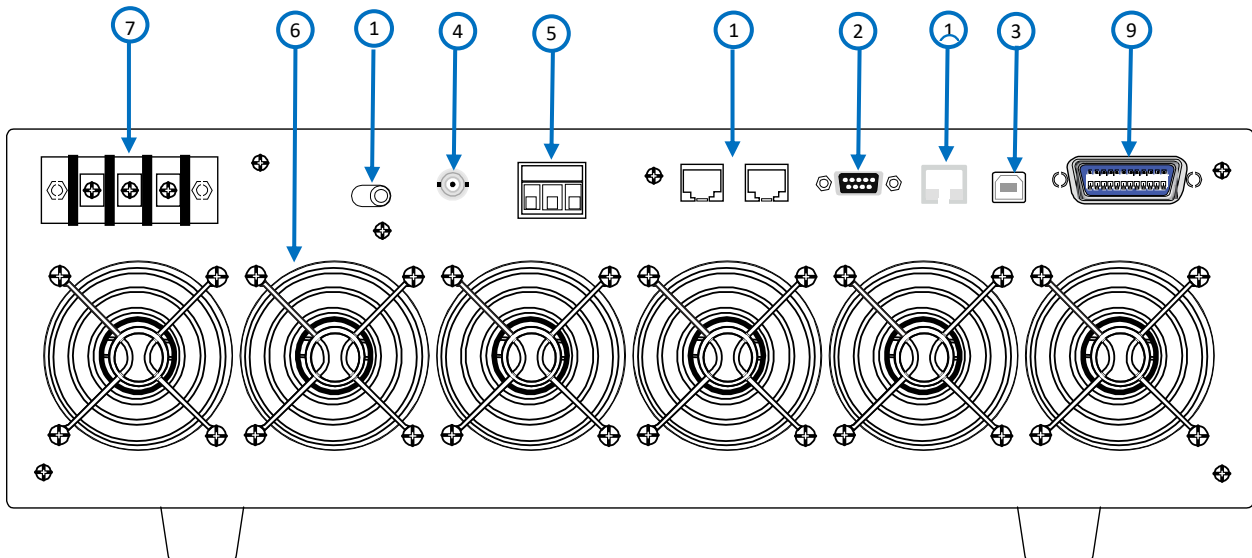

Figure 9 - Rear Panel 9803 and 9805

### Rear Panel Description

- ① LAN Interface

---

- ② RS-232 Interface

---

- ③ USB Interface

---

- BNC Interface Terminal**
- ④ *Used for external trigger and other functionality (see External BNC section)*

---

⑤	AC Output Terminal
⑥	Cooling Fans
⑦	AC Input
⑧	Fuse Box
⑨	GPIB Interface
⑩	System Bus (not used)
⑪	Line Voltage Selector

## 1.6 Display Overview

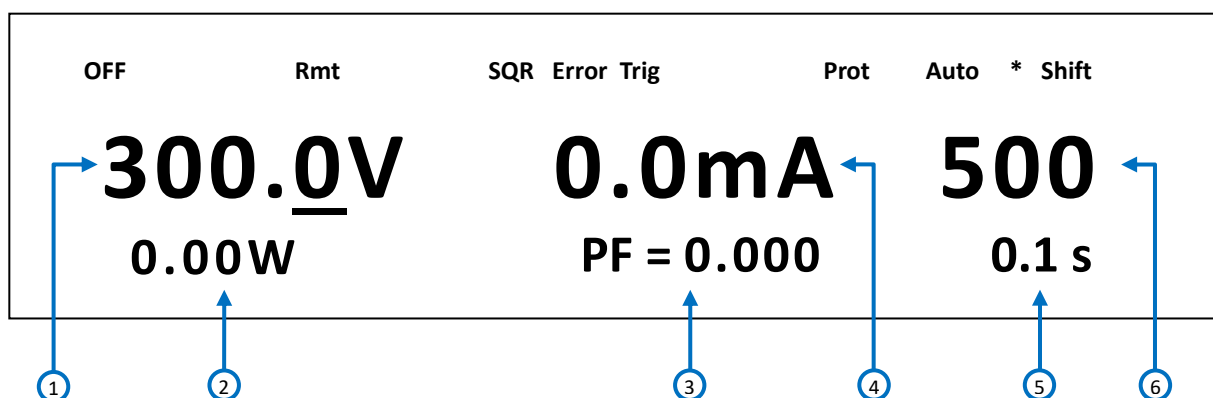

Figure 10 – Display Overview

### ***Display Description***

①	Programmed/Measured Voltage
②	Measured Power Output
③	Settings Display
④	Measured Current
⑤	Output ON timer
⑥	Programmed Frequency

---

<b>OFF</b>	Indicates output is disabled
<b>Rmt</b>	Indicates remote mode
<b>SQR</b>	Indicates service request
<b>Error</b>	Indicates an error has occurred
<b>Trig</b>	Indicates waiting for trigger (for list operation)
<b>Prot</b>	Indicates protection trip for over voltage or over temperature
<b>Auto</b>	Indicates power supply is in auto range
<b>*</b>	Indicates dimmer function is enabled
<b>Shift</b>	Indicates shift mode (for access to secondary button functions)
<b>Lock</b>	Indicates key lock is enabled

---

## 2 Getting Started

Before connecting and powering up the instrument, please review and follow the instructions in this chapter.

### 2.1 Input Power and Fuse Requirements

#### *Input Power*

This instrument has the following input power requirements:

##### **9801**

AC Voltage: **110 V ± 10% or 220 V ± 10 %**

Frequency: **47 Hz – 63 Hz**

##### **9803 and 9805**

AC Voltage: **110 V ± 10% or 220 V ± 10 %**

Frequency: **47 Hz – 63 Hz**

Use the line voltage selector on the bottom of the 9801 to set the input voltage of the instrument between 110 V and 220 V.

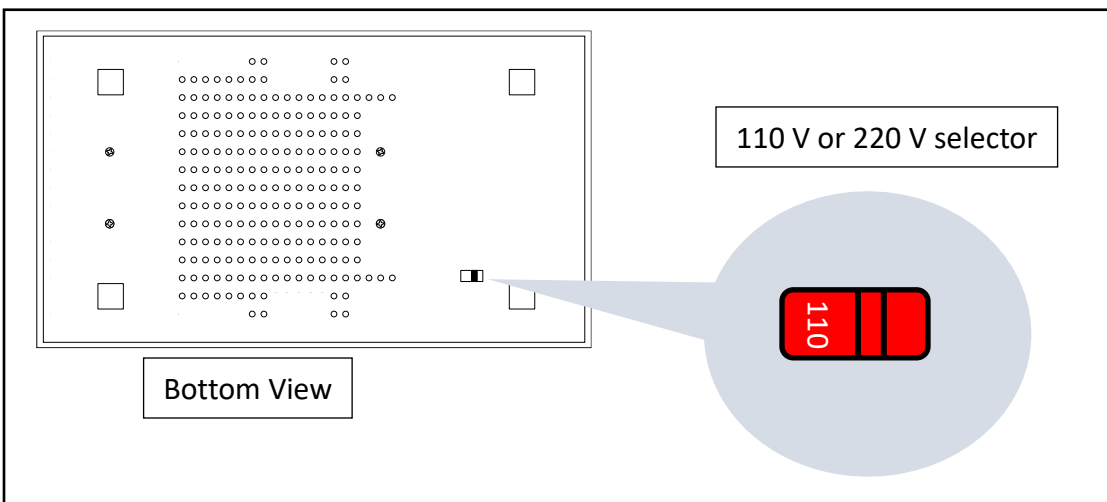

Figure 11 – Line Voltage Selector Location 9801

Use the line voltage selector on the rear panel of the 9803 and 9805 to set the input voltage of the instrument between 110 V and 220 V.

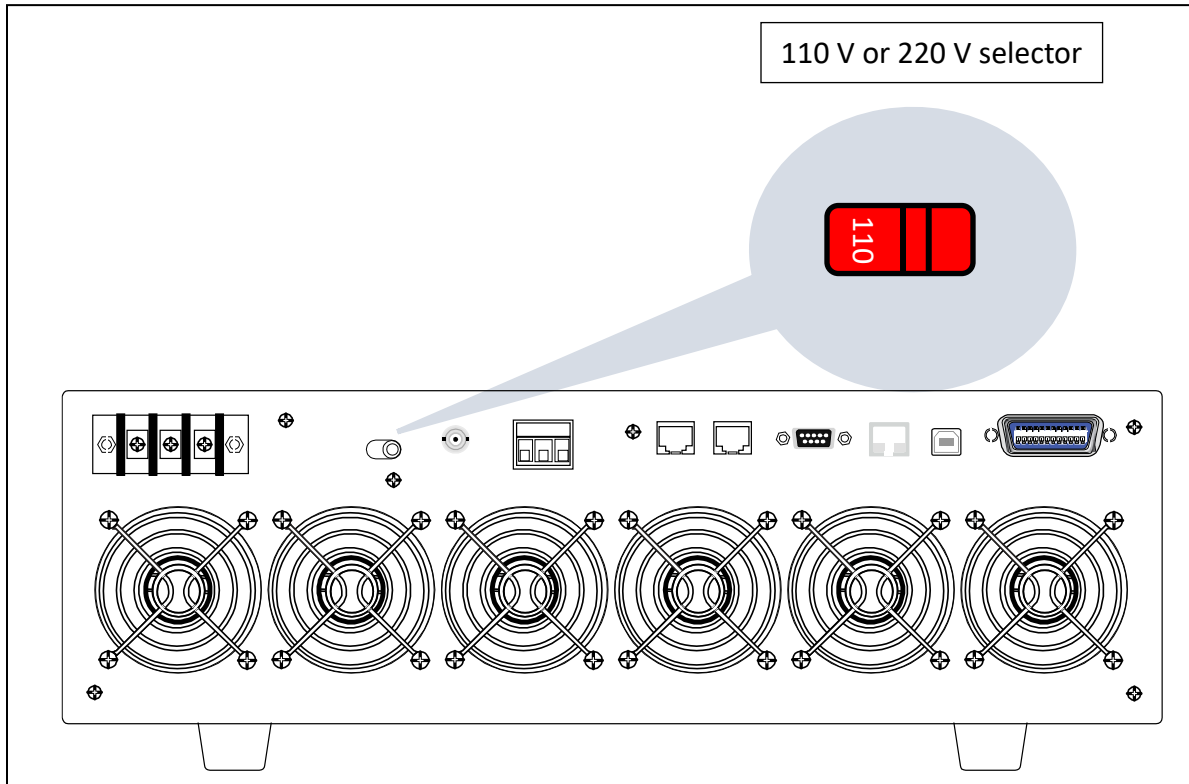

Figure 12 - Line Voltage Selector Location 9803/9805

---

**⚠ WARNING**

When changing the line voltage of the instrument, be sure to verify the fuse installed **BEFORE** powering ON the instrument. Failure to do so will damage the instrument and void its warranty. Refer to the *Fuse Requirements* section for details on changing the fuse.

---

---

**⚠ WARNING**

Disconnect all cables including the power cord from the instrument when changing the instrument's line voltage. After changing the line voltage setting, ensure the instrument has fuses of the proper ratings and types for the selected line voltage before applying line power.

**SHOCK HAZARD**



The power cord provides a chassis ground through a third conductor. Verify that your power outlet is of the

---



---

**three-conductor type with the correct pin connected to earth ground to prevent electric shock.**

---

Before connecting to an AC outlet or external power source, be sure that the power switch is in the OFF position and verify that the AC power cord, including the extension line, is compatible with the rated voltage/current and that there is sufficient circuit capacity for the power supply. Once verified, connect the cable firmly.

---

**⚠ WARNING**

**The included AC power cord is safety certified for this instrument operating in rated range. To change a cable or add an extension cable, be sure that it can meet the required power ratings for this instrument. Any misuse with wrong or unsafe cables will void the warranty.**

---

## ***Fuse Requirements***

An AC input fuse is necessary when powering the instrument. Refer to the table below for the fuse requirements.

<b>Model</b>	<b>Fuse Specification (110 V)</b>	<b>Fuse Specification (220 V)</b>
9801	T 10 A, 250 V	T 6.3 A, 250 V
*9803	2 x T15A, 250V	
*9805	2 x T30A, 250V	

Table 1 – AC Input Fuse Table

\* The 9803 and 9805 both have 2 fuses inside each instrument. The 9803 has two T15 A, 250V rated fuses while the 9805 has two T30 A, 250V fuses. **Both fuses must be installed for 110 V or 220 V operation.**

When 110 V line voltage is selected, both fuses are connected in parallel internally.

When 220 V line voltage is selected, both fuses are connected in series internally.

## ***Fuse Replacement***

Follow the steps below to replace or check the fuse:

### **9801**

1. Disconnect the AC input power cord.
2. Locate the fuse box in the rear panel, beneath the AC input receptacle.
3. With a small flat blade screwdriver, insert the blade into the fuse box slit to pull and slide out the fuse box as indicated below.
4. Pull out the fuse inside to check and/or replace (if necessary) for the desired line voltage operation.
5. Insert the fuse in the same location.
6. The fuse will now be locked and secured.

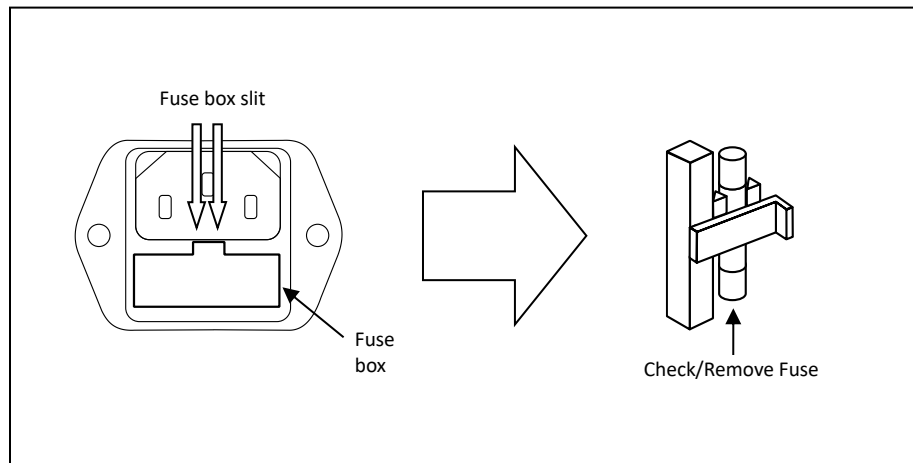

Figure 13 – Fuse Box

### **9803 and 9805**

1. Disconnect the AC input power before removing the cover of the power supply.
2. Remove all the screws shown in the image below, left and right sides and top.

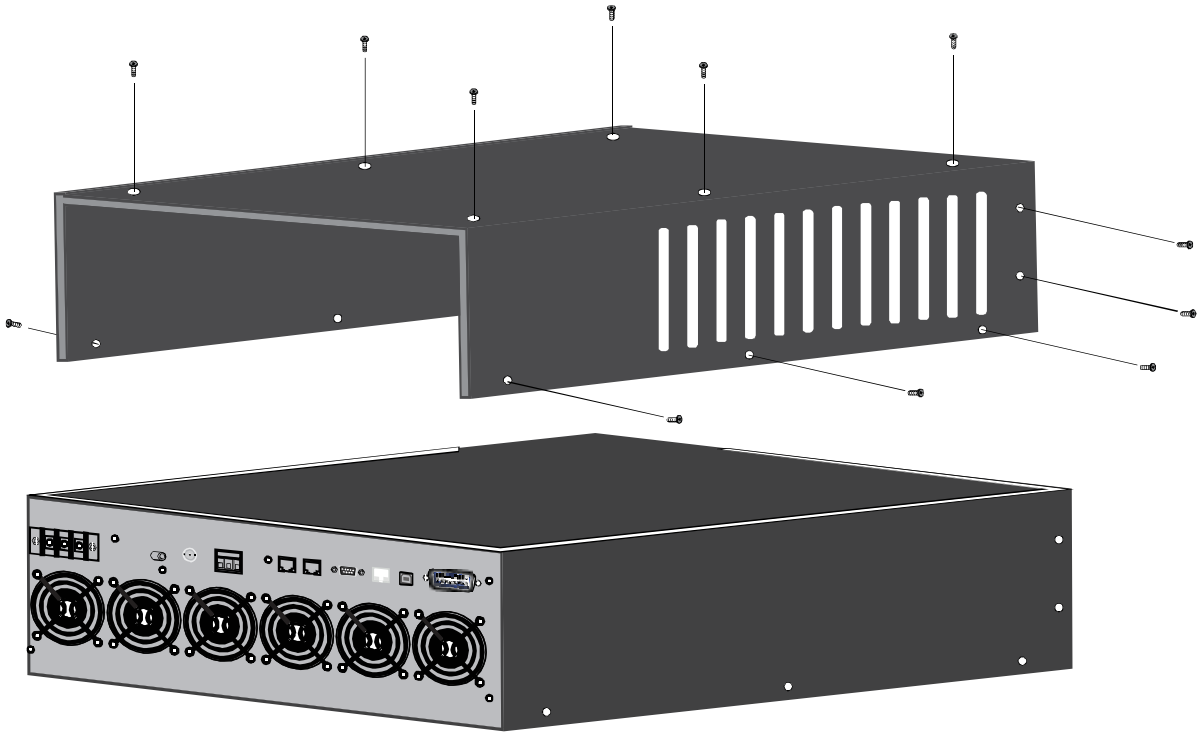

Figure 14 - Removing top cover

3. Remove the top cover of the power supply.
4. Locate the **two** fuse holders inside the power supply which are close to the AC input

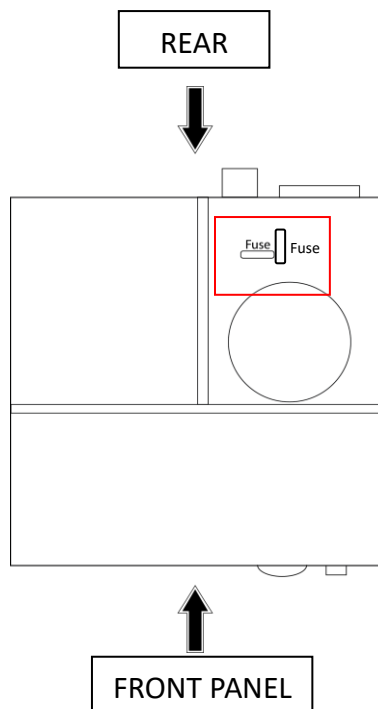

Figure 15 - Fuse Location

5. Remove both fuses inside unit to check and/or replace according to the desired line voltage operation (Refer to Table 1 – AC Input Fuse Table).
6. Insert the fuses in the same location.
7. The fuses will now be locked and secured.
8. Place back the top cover over the instrument and install all the screws before operation.

---

**⚠ WARNING**

**Disconnect all cables including the power cord from the instrument when replacing the fuse. Ensure the instrument has fuses of the proper ratings and types for the selected line voltage before applying line power.**

---

## 2.2 Input Connections

**For Models 9803 and 9805 only**

Please follow the steps below in to create a reliable and proper AC input connection, and refer to reference setup.

---

**⚠ WARNING**

**Check both ends of the power cord are disconnected from everything before connecting it to the AC input terminal. DO NOT make a connection if one end of the power cord is connected to a live circuit.**

---

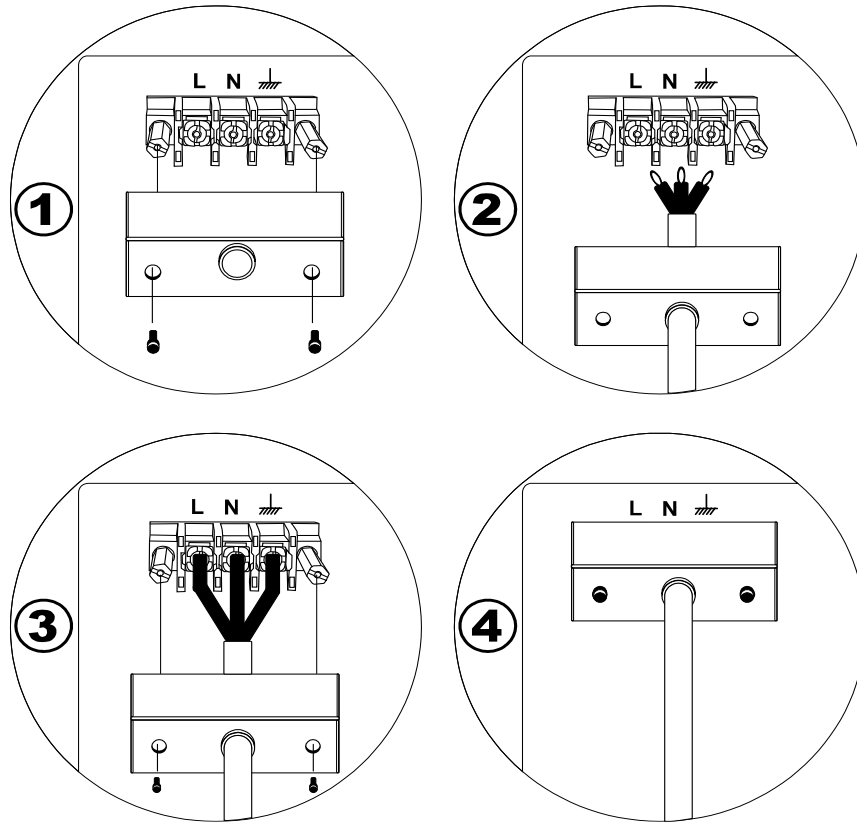

Figure 16 - AC Input Connection

**Step 1:** Remove the two screws of the AC input terminal cover.

**Step 2:** Slide the unterminated AC power cord through the hole of the AC input terminal cover.

**Step 3:** Place the three wire ends of the power cord to the correct terminals. Refer to below for reference. Securely tighten each wire to the terminals with the screwdriver.

**Step 4:** Place the AC input terminal cover over the input terminal and secure the two screws. Gently pull the cover and the power cord afterwards to ensure that both are secured to the instrument.

## Single-phase mains connections

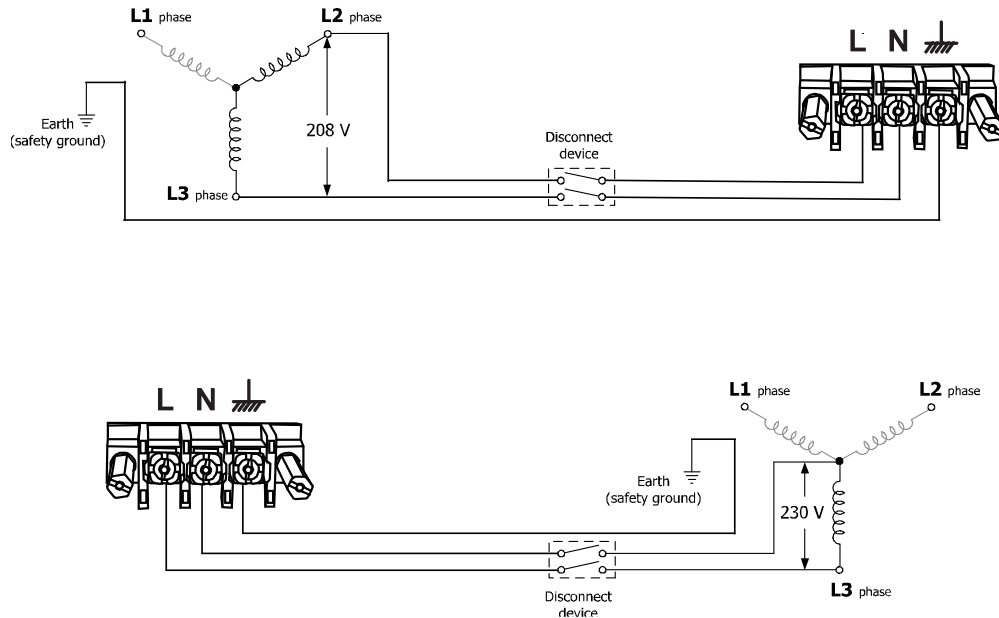

Figure 17 - Single Phase Mains Connection

## 2.3 Output Connections

The main front panel is equipped with one universal AC outlet for the 9801 and two universal AC outlets for the 9803 and 9805. These outlets accept all standard types of common AC power plugs. This AC output is isolated from the AC power input of the instrument.

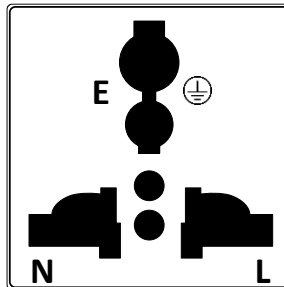

Figure 18 – Universal AC Output Socket

### **⚠ WARNING**

Before connecting wires to the output terminals, turn OFF the power supply to avoid damage to the instrument and the device under test (DUT). For safety, load wires must have a wire gauge size large enough to prevent overheating when the power supply operates at maximum short circuit output current.

---

**SHOCK HAZARD**

Hazardous voltages may exist at the outputs and the load connections when using this power supply. To protect personnel against accidental contact with hazardous voltages, ensure that the load and its connections have no accessible live parts. Ensure that the load wiring insulation rating is greater than to the maximum output voltage of the power supply.

---

The following types of AC power plugs are accepted by the Universal AC Output Socket.

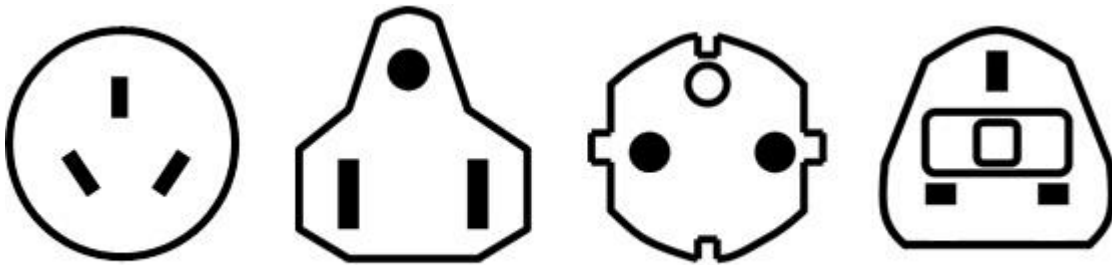

Figure 19 – Region Specific Power Cord Types

**9801**

The 9801 features a rear AC output terminal block which accepts a wire connection. This terminal block is isolated from the AC power input of the instrument.

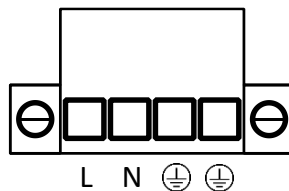

Figure 20 – Rear Panel AC Output Terminal

**9803 and 9805**

The 9803 and 9805 has a rear AC output terminal that is also isolated from the AC power input of the instrument. The connector is protected by an AC output terminal cover. Please follow the steps below to make a secure connection to the output terminal.

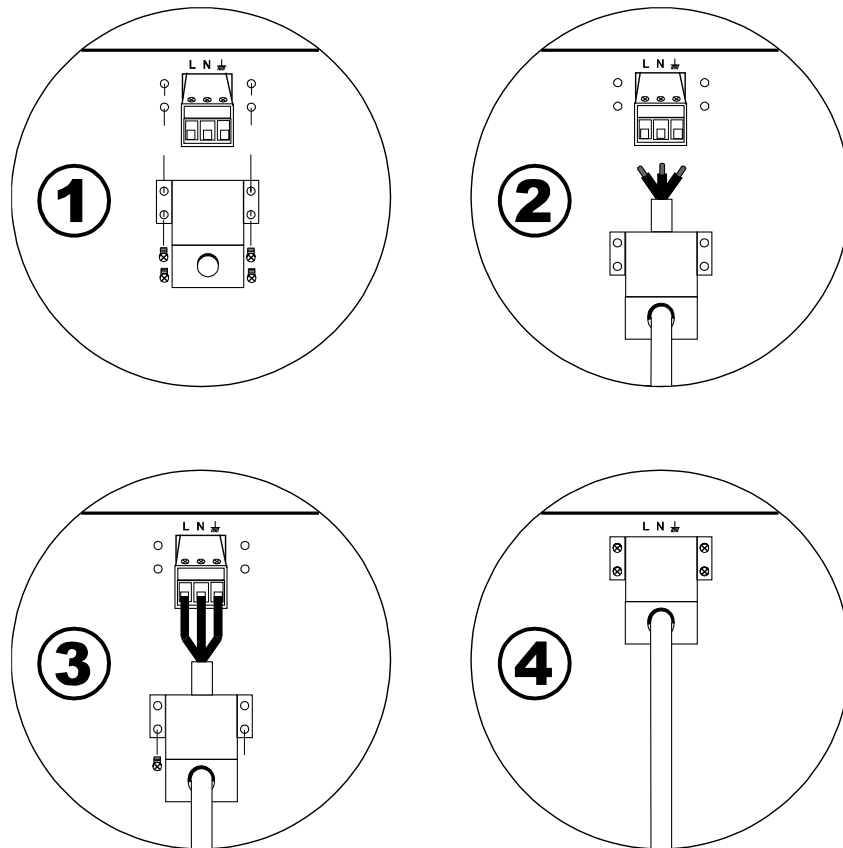

Figure 21 - Rear Panel Terminal Block Connection

**Step 1:** Remove the screws attached to the AC output terminal cover.

**Step 2:** Slide the wires (not supplied) through the hole of the AC output terminal cover. Note: Refer to Table 2 - Wire Gauge Rating to determine the type of wires to use.

**Step 3:** Place the three wire ends through the output terminal. Make note of the wires and ensure the proper color wire is connected to the right terminal. (i.e. In the US, Green/yellow-green is Ground, White is Neutral (N), and Black is Line/Hot (L)). Tighten down the wires so they are secured to the output terminal block.

**Step 4:** Place the AC output terminal cover over and secure it to the rear panel of the instrument by fastening the four screws on the sides of the cover.

---

**⚠ WARNING**

Before connecting wires to the output terminals, turn OFF the power supply to avoid damage to the instrument and the device under test (DUT). For

---



---

safety, load wires must have a wire gauge size large enough to prevent overheating when the power supply operates at maximum short circuit output current. Ensure the voltage selector is in the proper location (110V or 220V), failing to do so will result in damage to the DUT and/or power supply.

**SHOCK HAZARD**



Hazardous voltages may exist at the outputs and the load connections when using this power supply. To protect personnel against accidental contact with hazardous voltages, ensure that the load and its connections have no accessible live parts. Ensure that the load wiring insulation rating is greater than to the maximum output voltage of the power supply.

---

<b>AWG</b>	6	8	10	12	14	16	18	20	22
<b>I<sub>max</sub>(A)</b>	75	55	40	25	20	13	10	7	5
<b>mΩ/meter</b>	1.3	2.1	3.3	5.2	8.3	13.2	21	33.5	52.8

Table 2 - Wire Gauge Rating

## 2.4 Preliminary Check

Complete the following steps to verify that the power supply is ready for use.

**1. Verify AC Input Voltage**

Verify and check to make sure proper AC voltages are available to power the instrument. The AC voltage range must meet the acceptable specification as explained in “2.1 Input Power and Fuse Requirements”.

**2. Connect Power and Self-Test**

Connect AC power cord to the AC receptacle in the rear panel and press the power switch to the |(ON) position to turn ON the instrument. It will display the BIOS version then run through a self-test procedure with the screen shown in below:

# BIOS Ver 1.10

# System Selftest . . . .

..

If the EEPROM was damaged or the latest operation data in the EEPROM was lost, the VFD will highlight the “Error” indicator. Accessing the “Info” menu will give detailed error information. If self-test passes, VFD will display:

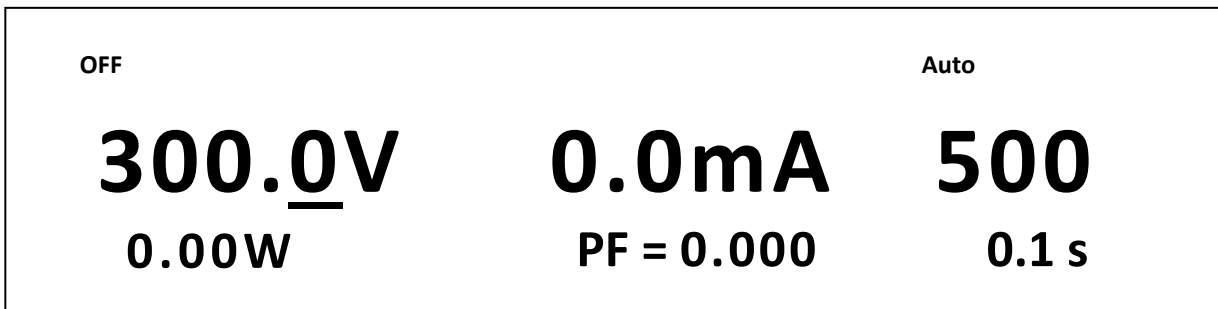

## Self-test Errors

If any errors occur during power up, please contact B&K Precision.

## Output Check

### Voltage and Frequency Check



Follow the steps below to check basic voltage output with no load connected.

1. Turn on the AC power source. The display will show the **OFF** annunciator above the voltage display.
2. Using the numeric keypad or the rotary knob, enter a voltage value. The voltage display will show the value you entered. If entering with the numeric keypad, press **Volt** first, then enter the value and press **Enter**.
3. Press the **FREQ** button and set the frequency using the numeric keypad or the rotary knob. If entering with the numeric keypad, make sure to press **Enter** after entering a value.
4. Enable the output by pressing **On/Off**, and the button will be illuminated. The **OFF** annunciator will disappear and the output timer will begin counting.
5. Once the output is ON, the voltage display will show the measured voltage at the output, which may fluctuate slightly from the voltage value entered in the previous step.

6. (Optional) You may also verify the output voltage and frequency by connecting the (L) and (N) terminals on the rear panel to an external multi-meter or an oscilloscope. Under normal operation, the measured value will be equal to or within the entered voltage and frequency value.
7. Ensure that the voltage can be adjusted from zero to the full rated output of the unit and verify the full frequency range is within specifications.

### ***Check Model and Firmware Version***

The model and firmware version can be verified by using the **\*IDN?** query remote command. It can also be found from within the menu system by following these steps:

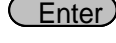
1. Press (Shift)  and press (Menu)  to enter the menu system.
2. Press the  arrow two times until **INFO** is blinking. Press , and the display will show the following screen:



# **PRODUCT INFO:**

**Model: 9801    Ver: 0.02 – 0.01**

3. The model is shown above as 9801, and the firmware version is shown as 0.02 – 0.01.
4. Press  to exit the menu and return to the normal display.

## 3 Front Panel Operation

### 3.1 Menu Options

All settings and parameters can be configured from the menu of the power supply. To access the menu, press (Shift)  and press (Menu) .

The menu is divided into the following sections and organized as follows:

#### SYSTEM

Init	Reset power supply settings to factory default values
Power-On	Configure power-on parameters
Power-Out	Configure power-on output state
Buzzer	Enable/Disable key sound
Trigger	Configure Trigger
Communication	Select communication interface

#### CONFIG



Volt-Min	Set minimum voltage limits
Volt-Max	Set maximum voltage limits
Freq-Min	Set minimum frequency limits
Freq-Max	Set maximum frequency limits
Irms-Protect	Configures current RMS protection setting
BNC-Set	Select external BNC connection setup
Ipeak-Protect	Configures current peak protection point
Dimmer	Configures dimmer output function
List-Set	Configure list start trigger
Meas-Freq	Select measure frequency range
Meas-Curr-Mode	Select measure current range
3Φ - option	Not used

#### INFO

Error Info	Displays error information (Shown only when an error has occurred)
Product Info	Displays model and firmware version
Product SN	Displays serial number
Record Info	Displays instrument information







#### *How to Access the Menu*

Before using the instrument, it is important to be familiarized with its menu structure and learn how to view or change settings and parameters. Follow the steps below to guide you in selecting menu options.

1. From the normal display, press (Shift)  and press (Menu)  to enter the menu.
2. The selected item will be blinking. Use  keys to move through the menu selections.

- When the desired menu section is blinking, press  to access its menu settings.
- Below is the display when **SYSTEM** is selected.

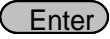

- The selected item will be blinking. Use  keys to move through the menu items. When there is a  on the right side of the display, that means there are more menu items available to select from. Similarly, a  will appear on the left side of the display when there are menu items to the left. Use the  keys accordingly to select the desired menu item.
- Press  to access the selected menu item.
- There may be parameters or options to select within each menu item. Follow the same instructions as described in the previous steps to select them. To save changes to a setting, press .
- To exit the menu at any time, press  twice.





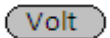

## 3.2 Configure Voltage and Frequency Output

The voltage, output range, frequency, and phase can be set from the front panel.

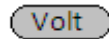
### Setting Voltage

The user has the ability to set the voltage within the range of 0.0 V to 300.0 V in all three units. When the  button is pressed, the button will illuminate. This puts the instrument into voltage set mode. There are three ways to set the output voltage through the front panel.

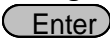

Follow the steps below to set the output voltage:

- From the normal front panel display, users can use the rotary knob, navigation arrow keys or the numeric keypad to enter the setting voltage.
- If entering using the rotary knob or navigation arrow keys, press  first so that the cursor selects the voltage display. Then use the  keys to change the cursor position and the rotary knob or the  and  keys to increase or decrease the voltage setting value. Then press  to set the voltage.
- If entering using numeric keypad, press  first so that the cursor selects the voltage display. Then, enter the voltage value using the numeric keypad and press  to set the voltage.

## Output Range

The AC sources will allow the user to select between High range and Auto range. For example, the 9801 voltage, current and apparent power in the High range are 300V/1.5A/300VA and 150V/3A/300VA in the low range. While all the models of the 9800 series have the same output voltage range, the output current range varies based on the unit's specifications. The user can choose the current range according to their specific requirements and those of the power units. When Auto range is chosen, the instrument will switch between high range and low range automatically.

To change between the two ranges, do the following:

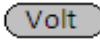
1. Press (Shift)  and then press (High/Auto)  to switch between High range and Auto range.
2. When High range is chosen, press the (Shift)  and then (High/Auto)  to switch to Auto range. The indicator "Auto" on the VFD display will be enabled. No indicator will show on the VFD display for the high range.

---







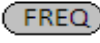

**Note: When the range is switched, the instrument will disable the output to protect the instrument and DUT (device under test) from potential damage.**

---

## Setting Frequency

The user has the ability to set the frequency within the range of 45.0 Hz to 500 Hz. When the  button is pressed, the button will illuminate. This puts the instrument into frequency set mode. There are three ways to set the output frequency through the front panel.



Follow the steps below to set the frequency of the AC signal:

1. From the front panel, users can use the rotary knob, navigation arrow keys or the numeric keypad to enter the frequency setting.
2. If entering using the rotary knob or navigation arrow keys, press  first so that the cursor selects the frequency display. Then use the   keys to change the cursor position and the rotary knob or the  and  keys to increase or decrease the frequency setting value. Then press  to set the frequency.
3. If entering using numeric keypad, press  first so that the cursor selects the frequency display. Then, enter the frequency value using the numeric keypad and press  to set the frequency.

## Setting Phase Angle

The AC output's start and stop phase angle can be adjusted within the range of 0.0° to 360.0°. This

function is widely used for startup and shutdown current impact tests and various rectifier performance tests.

When the (Shift)  and (Phase)  button are pressed, the following screen will be shown.

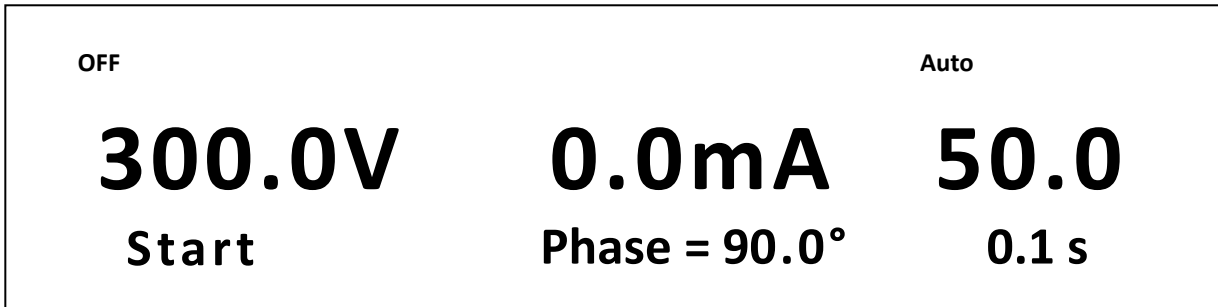

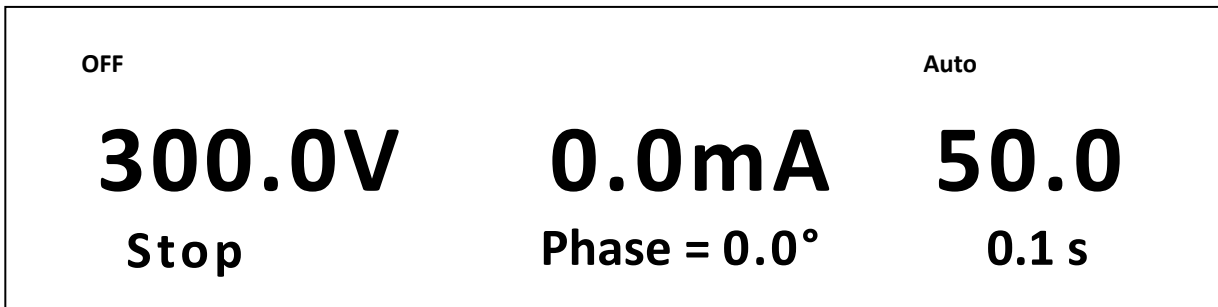

Use the numeric keys to set the start phase angle and press  to confirm the start phase setting. The following screen will be shown next.



Use the numeric keys to set the stop phase angle and press  to confirm the stop phase setting.

### 3.3 SYSTEM Menu

All setup procedures and settings explained in this section can be accessed from the **SYSTEM** menu. To access this menu, press (Shift)  and press (Menu) . When **SYSTEM** is blinking, press .

#### ***Restore Factory Default Settings***

All instrument settings can be reset back to their factory default values by doing the following:

---

**⚠ CAUTION**

Restoring the instrument to factory default will change all current instrument settings back to their default values.

---

1. From the **SYSTEM** menu, select **Init** and press **Enter** .
2. There are two options:
  - Esc** – This option will exit the menu.
  - Enter** – The instrument will return to the main display and all settings are now restored back to factory default. The table below lists some of the factory default settings.

**Table 3 - Factory Default Settings**

Voltage	0.0 V
Frequency	50.0 Hz
Start Phase	0.0
Stop Phase	0.0
Range	Auto
Power-Out Setting	Off
Power-On Setting	Sav0
Key Sound	ON
Trigger Source	Manual
Communication Interface	RS232
RS232 Settings	9600, 8, N, 1
LAN Settings	Gateway: 192.168.0.1 IP: 192.168.0.125 Mask: 255.255.255.0 Socket Port: 30000
Volt-Min	0.0 V
Volt-Max	300.0 V
Freq-Min	45.0 Hz
Freq-Max	500.0 Hz
Irms-Protect	3.000 A, Delay (max RMS current)
BNC-Set	I-Trigger
Ipeak-Protect	9.00 A, Delay (max peak current)
Dimmer Setting	Off
List-Set	On/Off
Output	Disabled



## ***Configure Power-On Settings***

The initial power-on settings of the power supply can be configured to either the default settings or the settings stored in data bank 0. Follow the steps below to configure this option:

1. From the **SYSTEM** menu, select **Power-On** and press **Enter** .
2. There are two options:  
**Rst** – Factory Default settings.  
**Sav0(Def)** – Settings stored in data bank 0 (See Save Settings).
3. Select the settings you want during power up, and press **Enter** to save changes.
4. To exit the menu at any time, press **Esc** twice.

## ***Configure Power-Out State***

The output state of the power supply can be configured to either off or the last state of the output before power down. Follow the steps below to configure this option:

1. From the **SYSTEM** menu, select **Power-Out** and press **Enter** .
2. There are two options:  
**Off(Def)** – Factory Default.  
**Last** – Output state before last power down.
3. To exit the menu at any time, press **Esc** twice.





## ***Enable/Disable Key Sound***

The instrument initially has key sound enabled from factory. To disable or enable the key sound, follow the steps below:

1. From the **SYSTEM** menu, select **Buzzer** and press **Enter** .
2. Select between the two options:  
**On(Def)** – Enable key sound  
**Off** – Disable key sound
3. Select the desired option and press **Enter** to save the change.
4. To exit the menu at any time, press **Esc** twice.

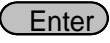
## Configure Trigger Source

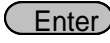
The trigger function is used to initiate a program in list mode. The trigger source can be set so that users can send a trigger from the front panel or through a remote command via remote interface. Follow the below steps to configure the trigger mode:

1. From the **SYSTEM** menu, browse and select **Trigger** and press .
2. There are two options:
  - Manual(Def)** – Manual trigger. Front panel trigger button is used to send a trigger (press (Shift)  and (Trigger)  to send trigger).
  - Bus** – Bus trigger. Remote command **\*TRG** is used to send a trigger.
  - Extern** – External TTL trigger (via the rear panel BNC connector).
3. To exit the menu at any time, press  twice.

## Communication Setup

There are several interfaces available for remote communication: USBTMC, RS-232, and LAN are standard for all units. GPIB is available on the 9803 and 9805 units only. This section will describe how to setup all the supported interfaces.

**Note:** The **RMT** indicator will appear on display when the power supply is successfully connected to a PC remotely through any remote interface. Keys on the front panel will be locked until the instrument is in LOCAL mode. To return to LOCAL mode from the front panel, press the (Local)  key. The **RMT** indicator will disappear when the instrument is in LOCAL mode.

### RS-232

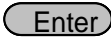
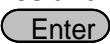

Follow the steps below to configure the power supply for RS-232 operation:

1. From the **SYSTEM** menu, browse and select **Communication** and press .
2. Select **RS-232(Def)** and press  to set to RS-232 for remote communication. The following display will be shown:

**RS232**

**9600 , 8 , N , 1**

3. **9600** is the baudrate; **8** is the data bits; **N** is the parity; **1** is the stop bit.

4. Use  to select between each serial settings, and use  to change the settings.
5. Below lists the options that can be changed for each setting:  
**Baudrate: 4800, 9600, 19200, 38400, 57600, 115200**  
**Data bits: 8**  
**Parity: N (None), E (Even), O (Odd)**  
**Stop bit: 1, 2**

---



**Note: The default is 9600, 8, N, 1**

---

6. All serial settings must match with the settings configured on the PC in order for communication to link successfully.

### **USBTMC**

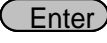
A **USB Type A to Type B cable** (i.e. USB printer cable) is required to connect the USB port in the rear panel to a PC. Follow the steps below to setup the power supply for remote communication.

1. From the **SYSTEM** menu, select **Communication** and press .
2. Select **USB** and press  to set to USBTMC for remote communication.
3. Install the USB driver on to your PC. For Windows® 7 or later users, this may install automatically. For other users, visit [www.bkprecision.com](http://www.bkprecision.com) and navigate to the product's page to download the driver or for more information.

---

**Note: Users who have LabVIEW™ or NI-VISA installed should have this driver in their system. In this case, driver download is not required.**

---

### **LAN (Ethernet)**

The LAN interface supports a raw socket connection and uses TCP protocols.

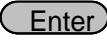
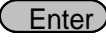
1. From the **SYSTEM** menu, select **Communication** and press .
2. Select **LAN** and press  to set to LAN for remote communication. The following display will be shown:

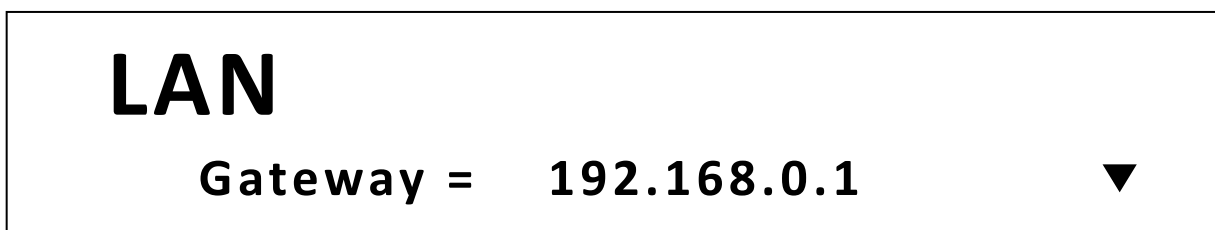

3. **192.168.0.1** is the Gateway IP address

- Use  $\Delta$   $\nabla$  to select between each LAN setting, and use the numeric keypad to change the settings. Press **Enter** to confirm setting changes
- Below list the options that can be changed for each setting:  
**Gateway: 000.000.000.000**  
**IP: 000.000.000.000**  
**Mask: 000.000.000.000**  
**Socket Port: XXXXX**
- All LAN settings must match with the settings configured on the PC in order for communication to link successfully.
- Press **Esc** several times to exit the menu.

### **GPIB (9803 & 9805 only)**

- From the **Config** menu, select **GPIB** and press the button. This will select the GPIB interface for remote communication.
- Use the keys to select Address 0-31 and press the **Enter** button.
- To exit the menu at any time, press the key **Esc** three times.

### ***Save/Recall Instrument Settings***

The instrument can save up to 10 instrument settings in non-volatile memory. Memory is allocated in 10 data banks to store settings (0 to 9).

#### **Save Settings**

- Set up all the instrument settings that you want to save.
- Then, press (Shift) **Enter** and **Recall** (Save). The display will show the following:



- Use the rotary knob or the numeric keypad to enter the memory location in which to store current instrument settings. Select between **0 – 9**. Press **Enter** to save to the selection location.
- If it saved successfully, there will be a message on display: **Save Success!**

## Recall Settings

1. Press the **Recall** button. Notice the button will be illuminated and the cursor on the display will disappear. This indicates **Recall** mode. Instrument settings can only be recalled when the instrument enters this mode.
2. Use the keypad to enter the memory location you want to recall. Enter a data bank number between **0** and **9**.
3. Once entered, the saved settings at the location will be immediately recalled.

---

**Note:** When in Recall mode, users can recall settings from different locations without having to press additional keys each time. For example, you can press **1** to recall settings in location one, and then press **5** to recall settings in location 5 immediately.

---

4. To exit **Recall** mode, press **Recall** and it will no longer be illuminated. The cursor on the display will reappear, indicating that the instrument is no longer in **Recall** mode.

## 3.4 CONFIG Menu

All setup procedures and settings explained in this section can be accessed from the **CONFIG** menu. To access this menu, press (Shift)  and press (Menu) **Select**. Select **CONFIG**, then press **Enter**. The following screen will be shown.



### *Voltage Limits*

The power supply allows users to define the voltage minimum and voltage maximum limits. This feature will prevent the user from entering a voltage setting outside of these limits. For example, if Volt-Min is set for 5 V and Volt-Max is set to 15 V, the unit will limit the settable voltage range to these limit settings.

### **Minimum Voltage Limit**

Follow the steps below to configure the Volt-Min setting:

1. From the **CONFIG** menu, browse and select **Volt-Min** and press **Enter**.
2. On the following screen, enter a voltage setting between 0.0 V to 300.0 V. Then press **Enter** to confirm. Please note, this setting will set the minimum (lower) voltage limit.
3. To exit the menu at any time, press **Esc** twice.

### **Maximum Voltage Limit**

Follow the steps below to configure the Volt-Max setting:

1. From the **CONFIG** menu, browse and select **Volt-Max** and press **Enter**.
2. On the following screen, enter a voltage setting between 0.0 V to 300.0 V. Then press **Enter** to confirm. Please note, this setting will set the maximum (upper) voltage limit.
3. To exit the menu at any time, press **Esc** twice.

## ***Frequency Limits***

The power supply allows for users to define the frequency minimum and frequency maximum limits. This feature limits the user from entering a frequency setting outside of these limits. For example, if Freq-Min is set for 50 Hz and Freq-Max is set for 60 Hz, the unit will limit the settable frequency range to these limit settings.

### **Minimum Frequency Limit**

Follow the steps below to configure the Freq-Min setting:

1. From the **CONFIG** menu, browse and select **Freq-Min** and press **Enter**.
2. On the following screen, enter a frequency setting between 45.0 Hz to 500.0 Hz. Then press **Enter** to confirm. Please note, this setting will set the minimum (lower) frequency limit.
3. To exit the menu at any time, press **Esc** twice.

### **Maximum Frequency Limit**

Follow the steps below to configure the **Freq-Max** setting:

1. From the **CONFIG** menu, browse and select **Freq-Max** and press **Enter**.
2. On the following screen, enter a frequency setting between 45.0 Hz to 500.0 Hz. Then press **Enter** to confirm. Please note, this setting will set the maximum (upper) frequency limit.
3. To exit the menu at any time, press **Esc** twice.

## ***Current Protection***

The power supply features RMS and peak current protection. When the RMS protection current is set, the unit will monitor the RMS continuous current and it will shut off the output if the load continuously exceeds the set current. When the peak protection current is set, the unit will monitor the peak current so that it will shut off the output if the load exceeds the set current briefly. A one second protection delay can be selected to allow the instrument to output current exceeding the protection limit momentarily without tripping the protection function and shutting off the output.

### **Current (RMS) Protection Point**

Follow the steps below to configure the Irms-Protect setting:

1. From the **CONFIG** menu, select **Irms-Protect** and press **Enter**.
2. On the following screen, enter a frequency setting between 0.000 A to max current of the unit. Then press **Enter** to confirm.
3. Then choose between **Immediate** or **Delayed** and press **Enter** to confirm. Immediate shutoff will shut off the output as soon as a continuous current exceeds the current setting. Delayed shutoff will shut off the output with about a 1 second delay when the continuous current exceeds the current setting.
4. To exit the menu at any time, press **Esc** twice.

### **Current (Peak) Protection Point**

Follow the steps below to configure the Freq-Max setting:

1. From the **CONFIG** menu, select **Ipeak-Protect** and press **Enter**.
2. On the following screen, enter a frequency setting between 0.000 A to max current of the unit. Then press **Enter** to confirm.
3. Then choose between **Immediate** or **Delayed** and press **Enter** to confirm. Immediate shutoff will shut off the output as soon as any current spike exceeds the current setting. Delayed shutoff will shut off the output with about a 1 second delay when any current spike exceeds the current setting.
4. To exit the menu at any time, press **Esc** twice.

## ***External BNC***

The power supply features a BNC connector that can be configured to be used as an external trigger, to enable or disable the main output, AC phase synchronization, or to output the state of the main output. The BNC has a constant 5V DC signal with a pull-up resistor internally.

Follow the steps below to configure the BNC port setting:

1. From the **CONFIG** menu, browse and select **BNC-Set** and press **Enter**.
2. On the following screen, select between **I-Trigger**, **I-Ri**, **O-Sync**, or **O-On**. Then press **Enter** to confirm.
  - **I-Trigger**: Select this option to configure the BNC port as an input trigger to start or stop a list.

**Note:** In order to externally trigger a list, **List-Set** option in the **CONFIG** menu must be set to **Trigger**. See “Configure List Setting” for details.

By default, the BNC port has an open-circuit voltage of 5 VDC. A trigger is registered when an external TTL logic signal is sent. The instrument triggers off a falling edge from logic high (5 V) to low (0 V).

A negative TTL level pulse signal with pulse width  $> 50 \mu\text{s}$  can be used as a trigger, as illustrated below:

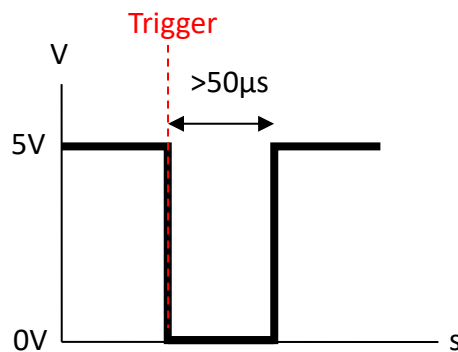

Figure 22 - TTL Pulse Width

- **I-Ri**: Selecting this option will configure the BNC port as an input to control the On/Off state of the main AC output. It can be used as an emergency soft output switch to quickly configure the output to 0 V, 0 A. To control the output, follow the steps below.
  1. Press **On/Off** to turn ON the main AC output. The green backlight should be illuminated.
  2. To keep the output turned ON, leave the BNC port open. To turn the output OFF, short the BNC port. Refer to the diagram below.



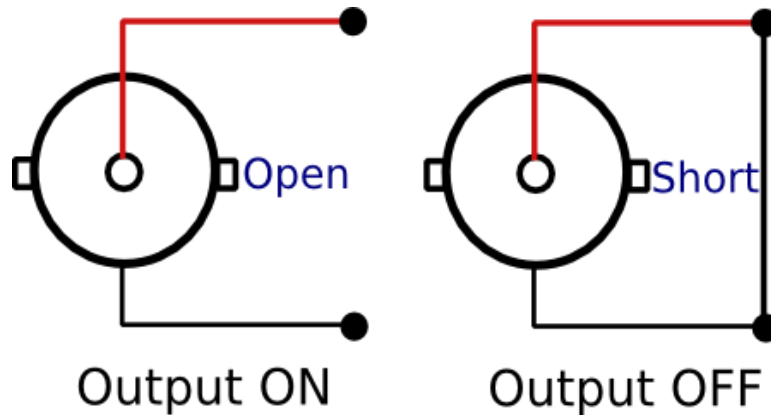

Figure 23 - Rear Panel BNC Output Control

### ⚠ CAUTION

The External BNC port is used as a soft output control. However, it does not disable the main AC output control, which can be switched by pressing the **On/Off** button. Thus, when not using the external BNC to control the output state, ensure that **On/Off** is pressed to disable the output. The On/Off button's backlight LED will turn off.

- **O-Sync:** Selecting this option will configure the BNC port as a sync output signal, which will output a 5V TTL logic signal that is synchronized with the main output.

**Note:** As output frequency increases, there may be an increase of the sync offset (< 50  $\mu$ s max.) between the main output and the sync output.

- **O-On:** Selecting this option will configure the BNC port as an output to monitor the state of the AC output. A 5 V TTL logic high signal means the output is ON. A 0 V TTL logic low signal means the output is OFF.

3. To exit the BNC port setting menu at any time, press **Esc** once.

## 3.5 Dimmer Output Simulation

The power supply features a dimmer output simulation function that allows for users to cut off part of the mains voltage to vary the RMS voltage fed to the load under test, sometimes referred to as phase cutting. The range for the phase adjustment is from 0.0 – 180.0°. This function also gives two options to cut off the main output voltage by either the beginning of the sine wave or at the tail end of the sine wave. Cutting off the beginning of the sine wave is called leading edge dimming and cutting off the end of the sine wave is called the trailing edge

dimming. Below is an illustration of a leading and trailing edge dimmer:

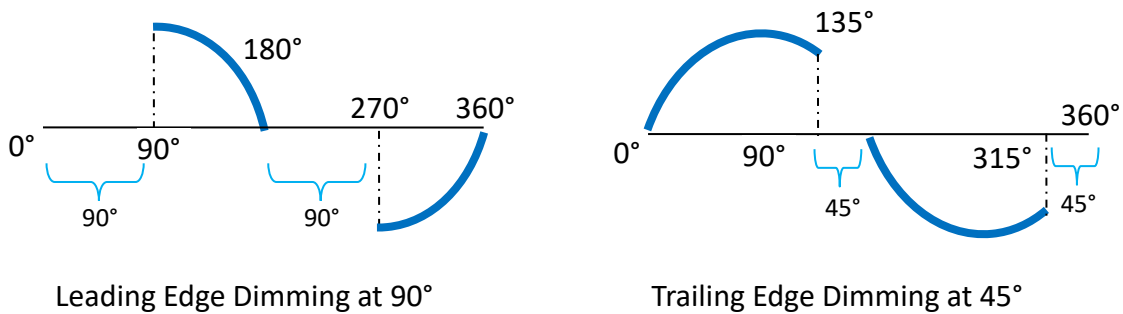

Figure 24 – Leading and Trailing Edge Dimming

The dimmer feature can be used for many test applications such as motor control (fan speed control, etc.) and lighting (LEDs, incandescent, etc.).

Follow the steps below to configure the dimmer function setting:

1. From the **CONFIG** menu, browse and select **Dimmer** and press **Enter**.
2. On the following screen, select between **LeadingEdge**, **TrailingEdge**, or **Off**. Then press **Enter** to confirm.
  - **LeadingEdge** – Enables the dimmer function with leading edge selected. To change the phase angle, see the instructions below.
  - **TrailingEdge** – Enables the dimmer function with trailing edge selected. To change the phase angle, see the instructions below.
  - **Off** – Disables the dimmer function.
3. To exit the menu at any time, press **Esc** twice.

**Note:** If the dimmer function is enabled, a “\*” indicator will be shown on the VFD display.

To select and change the phase for dimmer mode:

1. Press (Shift) **9** and press “\*Dimmer” (“9”).
2. On the following screen, enter a dimmer angle setting between 0.0° – 180.0°, using either the rotary knob or numeric keypad. Then press **Enter** to set.

### 3.6 List Mode

The power supply has a list mode feature that allows storing programmed sequences into internal non-volatile memory and recalling and running them per configured parameters. A

total of 100 steps can be configured for each sequence, and a total of 10 sequences are available for storage. With List mode enabled, the AC waveform sequences with various ranges can be generated. The power line disturbance (PLD) waveforms may also be added, as required, to simulate fluctuation of network voltages and evaluate the result of a unit under such situation.

There are three steps to set up for programming and running a list program (in order):

1. Configure List setting
2. Edit List (Program) File
3. Recall and Run Program

The following sections will go into the details of setting up all three.

---

**Note: It is recommended that the Trigger Source be configured prior to setting up the configurations. Additionally, the output of the power supply must be disabled prior to setting up the configurations.**

---

---

**Note: At the start of a list program, there is a 50 ms delay in which the power supply will output 0 V before it begins outputting according to the parameters in the first step of the list.**

---

## ***Configure List Setting***

In list mode, users are able to trigger/initiate a list using various sources such as, manual trigger (front panel\*), bus line trigger, or external BNC\*\*. Please see the Configure Trigger Source section for details on how to select a trigger source.

\*There are two manual trigger options to start a list, see *below* for more details.

\*\*See the "[External BNC](#)" section for details on how to configure.

### **List-Set**



Users have the option to start a list program by simply pressing the **On/Off** button or sending a trigger signal to the unit.

Follow the steps below to configure this setting:

1. From the **CONFIG** menu, browse and select **List-Set** and press **Enter**.
2. On the following screen, select between **On/Off** or **Trigger**. Then press **Enter** to confirm.
  - **On/Off** – selecting this option will allow the On/Off button to start a list.

- **Trigger** – selecting this option will allow a trigger signal to start a list.
3. To exit the menu at any time, press  twice.

## **Edit List File**

Each list can store from 1 to 100 steps and can be set to repeat from 1 to 1000 times. To access the edit list menu, press (Shift)  and press “List” (“8”). Now select the “Edit” option and press . Each step’s parameters contain a voltage, frequency, width (time to hold the step), slope, and PLD settings. The adjustable range and operation for each of these parameters are specified in table below:

**Table 4 - Step Parameter Range**

<b>Parameter</b>	<b>Operation Description</b>	<b>Input</b>
Step Count	Sets the number steps in the list	1 – 100
List Repeat	Sets the number of times to repeat the list	1 – 10000
Voltage Setting	Sets the step’s voltage	0.0 V – 300.0 V
Frequency Setting	Sets the step’s frequency	45.0 Hz – 500 Hz
Slope	Sets the slope time to the next step	0.0 s – 999.9 s
Dwell Units	Sets the unit for the step width	Second, Minute, Hour
Dwell Time (step width)	Sets the dwell time/step width	0.0 – 999.9
SD State	Enables or disables the PLD state (See Disturbance Simulation)	Enable, Disable
SD Continue*	Selects whether to create PLD continuously. If yes is selected, the power supply will create the programmed PLD in intervals of 100 ms. If no, the programmed PLD will not output when the step is ran.	No, Yes
SD Voltage*	Sets the voltage level of the PLD.	0.0 V – 300.0 V
SD Site*	Set the starting time of PLD. With the restriction of frequency, the max settable time is 25 ms.	0.0 ms – 25.0 ms
SD Time*	Set the duration time of the PLD.	0.0 ms – 5000.0 ms
List Save	Select Yes to save the list to memory bank 0-9	Yes, No (If yes, select memory 0-9)

\*Parameter only available when SD State is set to “Enable”.

## Setting PLD Parameters

**SD State** – This enables or disables the PLD simulation. Enable it to include PLD in the list step.

**SD Continue** – This selects whether to create the PLD continuously or not. If **SD State** is enabled, this should be set to **Yes** so that it will simulate the PLD.

**Note:** The programmed PLD will output continuously in intervals of 100 ms. If the step dwell time reaches before the 100 ms interval, the power supply will output the next step immediately and skip the step's PLD simulation.

**Note:** After the initial 50 ms delay from the start of a list program, the power supply will output 100 ms (or longer because after 100 ms, the last cycle must be completed) of the first step before the first PLD occurs. If the first step's dwell time is set to the minimum of 0.1 s, then 200 ms of the first step will output instead before the first PLD occurs. Thereafter, the PLD will output in 100 ms intervals. See the graph below:

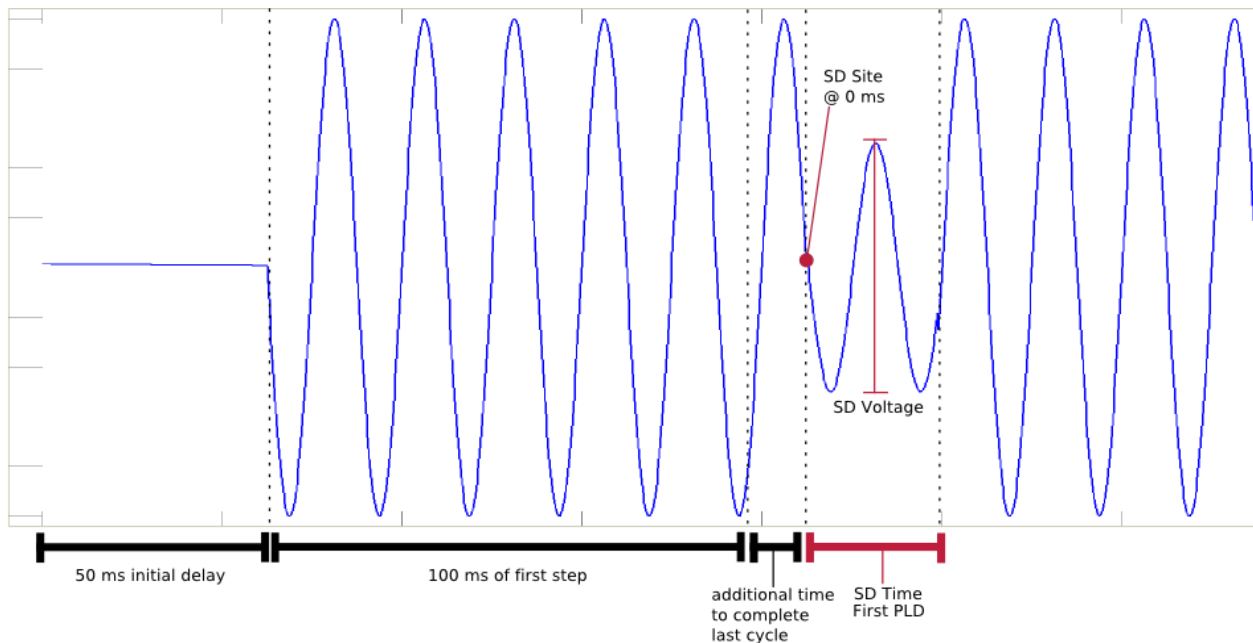

Figure 25 – Initial Start of a List

**SD Voltage** - This parameter defines the voltage level of the PLD.

**SD Site** – This parameter defines the time location (with reference to the beginning of a period of the output) in which to output the PLD. Figure 25 above shows the output of the first step of a list with SD Site set to 0.0 ms.

**SD Time** – This parameter defines the duration of the PLD in time.

**Note:** If the SD Time is greater than the Step Dwell Time, the PLD will carry over to the next step(s) of the list until either the SD Time is reached or the end of the last step in reached, whichever comes first.

**Note:** The simulated PLD will output at the same frequency as the step frequency.

## ***Recall and Run Program***

Once the program is configured and stored into memory, they can be recalled and triggered to run.

### **Recall Program**

Follow the steps below to recall a stored program from memory:

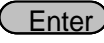
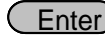
1. From the **LIST** menu (press (Shift)  and press “**List**” (“8”)), use the arrow keys to select **Recall** and press . The display will say **RECALL LIST** with the prompt **Recall List = 0**.
2. This is the location number where the program is stored in. Select a number between 0 to 9 with the rotary knob or the numeric keypad, then press .
3. Once selected, the display will read “Recall Data Success” and will return back to the **LIST** menu.

### **Run Program**

To run a program list after it is recalled, the trigger source must be configured **first**. Refer to “Configure List Setting” to set up the trigger source settings.

Follow the steps below to run the program:

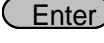
1. Assuming the stored program has already been recalled, from the **LIST** menu, with **Disable** selected, press the up or down key to select **Enable** and press . The **Trig** indicator will appear at the top middle of the display, as shown below:

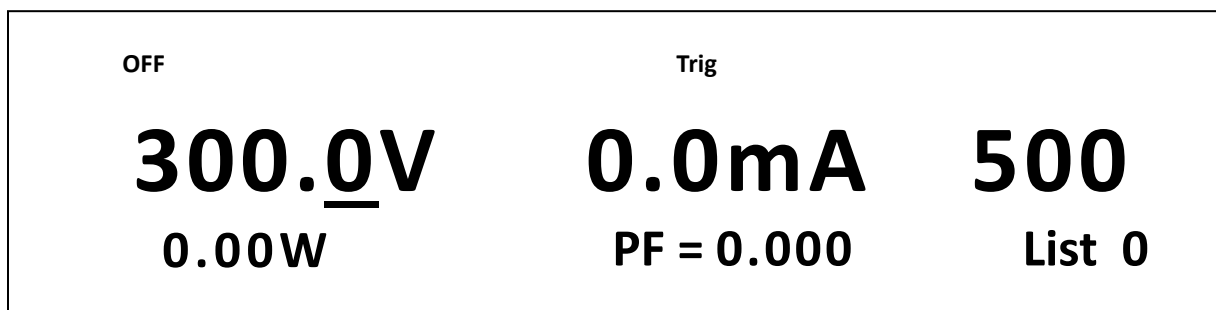

**Note:** The “0” next to “List” in the display above is the step number indicator.

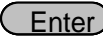
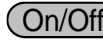
2. If the **Trigger Source** configured in Configure List Setting is set to **Manual (Def)**, then the front panel trigger key (Press (Shift)  and then  ) or the  key (see List-Set section to configure this option) can be used to initiate the program.

3. Once triggered, the **Trig** indicator will disappear and the **Enter** key will begin to blink.
4. If the output is not enabled, press the **On/Off** key to enable (ON) the output and allow the list to run.
5. When the program ends, the **Enter** will stop blinking and the **Trig** indicator will reappear again.

**Note:** If the Trigger Source is configured to BUS, use the remote command for sending triggers over any of the remote interface available. Refer to the programming manual for details.

If the Trigger Source is configured to Extern, then use the external BNC to trigger the list.

## Power Line Disturbance Simulation (PLD)

In list mode, the user has the ability to enable or disable the power line disturbance (PLD) simulator. If enabled, an extended list of options will become available to easily simulate many different power line disturbance conditions. Some of these waveforms include surge, sag, and dropout waveforms. The following example shows a dropout waveform:

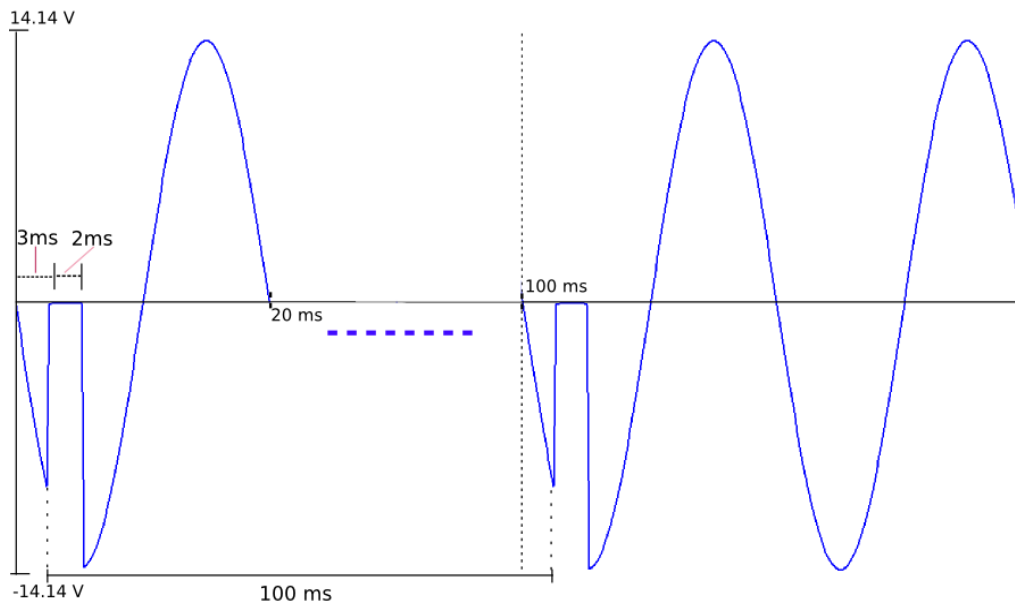

Figure 26 – Dropout Waveform

To create the waveform above, access the list mode as described *above* and enter the following parameters in the list mode file.

Table 5 - Step Parameter Range

Parameter	Input
Step Count	1
List Repeat	Any
Step 0 Voltage	10.0 V
Step 0 Frequency	50.0 Hz
Step 0 Slope	0.0 s
Dwell Units	Second
Step 0 Dwell	1
SD State	Enable
SD Continue	Yes
SD Step 0 Voltage	0.0 V
SD Step 0 Site	3.0 ms
SD Step 0 Time	2.0 ms
List Save	Yes
Save data bank	0

Once the list is saved to the desired memory bank, recall and run the program list by choosing the correct memory location (please see the *“Recall and Run Program”* for further details).

### 3.7 Sweep Mode

Sweep mode is used to create a sweep output with user-definable voltage and frequency settings. The voltage and frequency settings may be selected by setting the initial voltage, final voltage, step voltage, initial frequency, final frequency, step frequency and step time. The step time may be indicated in seconds, minutes or hours. Once the sweep starts, the power supply will cycle through the voltage steps (from initial to final voltages) starting with the initial frequency.

Then the power supply will step to the next frequency and cycle through the voltages steps (from initial to final voltages) again and repeat through all frequency steps until the sweep is complete. Sweep can also be used to evaluate the efficiency of switching power supplies or capturing the operating power requirements of the device under test.

The AC power supply can sweep up or down depending on configured start and stop voltage and/or frequency. Once the sweep is completed, the results are displayed and include the measured voltage, current, frequency, power factor, and the maximum power output that occurred during the sweep. A maximum of 10 sweep profiles may be stored and recalled.



---

**Note: If range is set to Auto and the sweep profile goes over or below 150 V, there will be a 50 ms delay during that instance in which the instrument will output 0 V. This delay is required for the instrument to switch ranges.**

---

Below are some examples of the type of sweep that can be setup and output from the power supply.

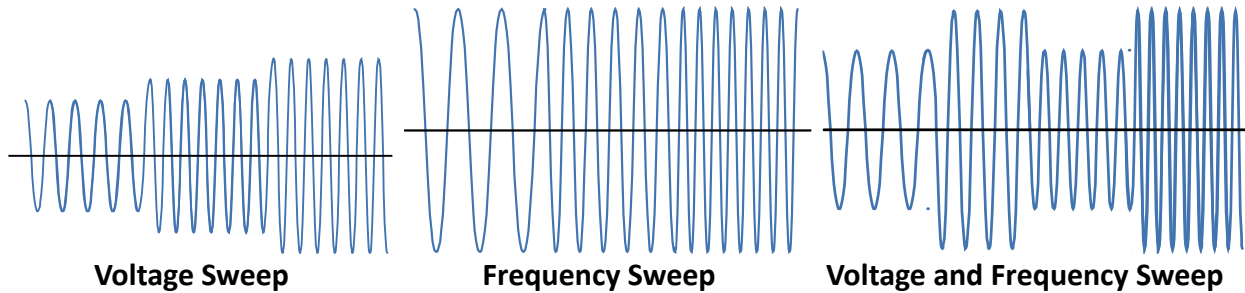

There are two steps to set up a sweep output (in order):

1. Edit Sweep File
2. Recall and Run Program

The following sections will go into the details of setting up these steps.

### ***Edit Sweep File***

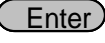
To access the edit list menu, press (Shift)  and press "7" ("Sweep"). Now select the "Edit" option and press . The adjustable range and operation for each of the sweep parameters are specified in table below:

**Table 6 - Sweep Parameter Inputs**

<b>Parameter</b>	<b>Operation Description</b>	<b>Input</b>
Start Voltage	Sets the start voltage	0.0 V – 300.0 V
End Voltage	Sets the end voltage	0.0 V – 300.0 V
Step Voltage	Sets the voltage step	0.1 V – 300.0 V
Time Unit	Sets the unit for the step time	Second, Minute, Hour
Step Time	Sets the step time	0.1 – 999.9
Start Frequency	Sets the start frequency	45.0 Hz – 500 Hz
End Frequency	Sets the end frequency	45.0 Hz – 500 Hz
Step Frequency	Sets the frequency step	0.1 Hz – 500 Hz
Sweep Save	Select Yes to save the sweep to memory bank 0-9	Yes, No (If yes, select memory)

		0-9)
--	--	------



**Note:** The sweep function will step through all of the voltage steps at the first frequency, then step through the voltages for the next step frequency until the sweep is complete.

***Recall and Run Sweep***

Once the sweep file is configured and stored into memory, it can be recalled.

**Recall Sweep**

Follow the steps below to recall a stored sweep file from memory:



1. From the **SWEEP** menu (press (Shift)  and press “7” (“Sweep”)), use the arrow keys to select **Recall** and press . The display will say **RECALL SWEEP** with the prompt **Recall Sweep = 0**.
2. This is the location number where the program is stored in. Select a number between 0 to 9 with the rotary knob or the numeric keypad, then press .
3. Once selected, the display will read “Recall Data Success” and will return back to the **SWEEP** menu.

**Run Sweep**

Follow the steps below to run the recalled sweep file:

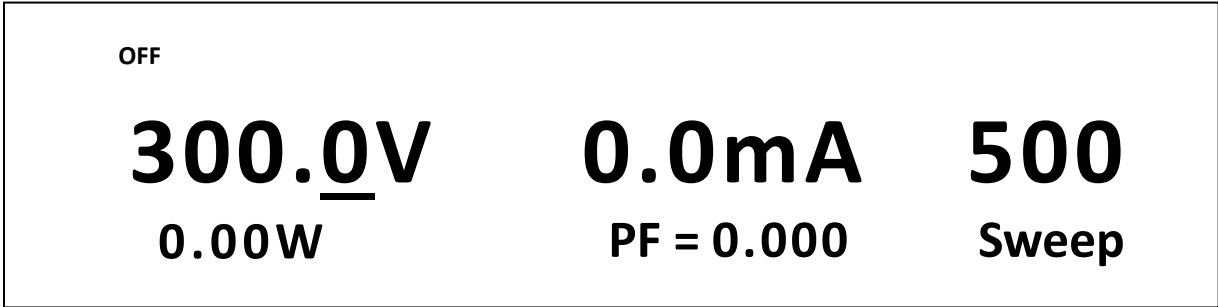
1. Assuming the stored sweep has already been recalled, from the **SWEEP** menu, with **Disable** selected, press the up or down key to select **Enable** and press . The **Sweep** text will appear below the frequency of the display, as shown below:



2. Press the  key to enable (ON) the output and allow the sweep to run. The  key will begin to blink while the sweep is running. When the sweep ends, the  will stop blinking and the output will shut off automatically.

## 3.8 Measured Power Output and Settings Display

By default, the front panel displays the real power measured in watts (W) and at the same time displays the power factor (PF). However, the power supply can also display the apparent power in Volt-Ampere (VA) along with the peak current (A pk).



The user can toggle between the parameters simultaneously displayed: W and PF, and VA and A pk by pressing the **Select** button.

## 3.9 Key Lock

The front panel keys can be locked to prevent unwanted changes to output settings and power supply configurations. Follow the steps below to enable/disable key lock.

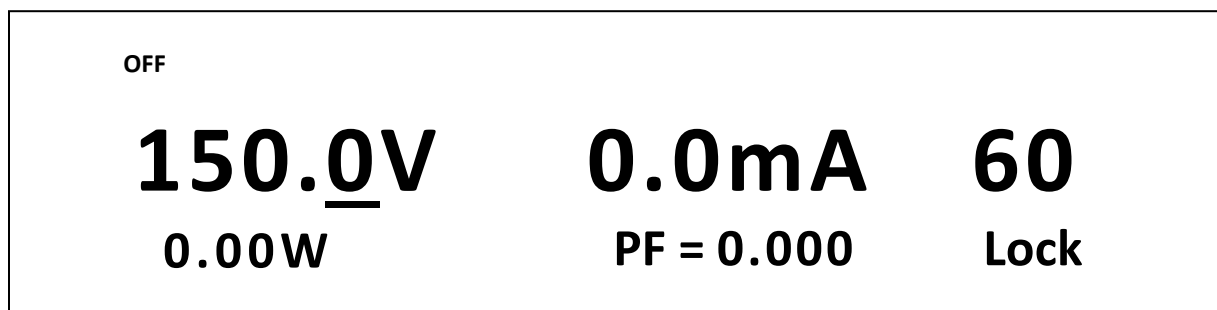
1. Press (Shift)  and (Lock) **On/Off**. The follow display will be shown, indicating that the front panel keys are locked.



2. All keys are now disabled except for (Shift) , **On/Off** (Lock function and output state), and **Select** (to change display readback).
3. To unlock the keys again, press (Shift)  and again **On/Off**. The “Lock” indicator will disappear and all keys will be enabled.

# 4 Remote Operation

## 4.1 Interface Connection

## RS-232

For RS-232 connectivity, refer to the diagram below for pin out information. The RS-232 is labeled in the rear panel and it is a female DB-9 interface. To select this interface to communicate with the unit, please see *Communication Setup*.

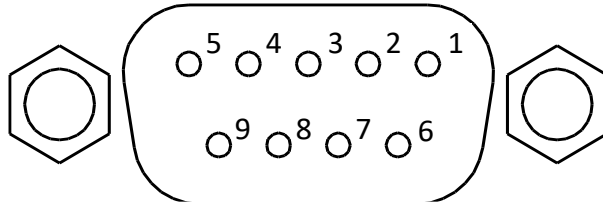

PIN	Description
1	-
2	TXD, Transmit Data
3	RXD, Receive Data
4	-
5	GND
6	-
7	CTS, clear transfer
8	RTS, ready to transfer
9	-

A straight pin-to-pin DB9 female to DB9 male serial cable is required for using the RS-232 interface. Do not use a null modem or crossover DB9 serial cable.

## USB

The instrument has a USB interface (USBTMC) on the rear panel for remote communication. To select this interface to communicate with the unit, please see *Communication Setup*.

## LAN





The LAN interface uses an Ethernet (RJ-45) connection on the rear panel and supports a socket connection. To select this interface to communicate with the unit, please see *Communication Setup*.

## GPIB

The 9803 and 9805 can be configured with a GPIB address from 1-31. To communicate via GPIB, connect a GPIB cable to the GPIB interface on the rear panel, as illustrated below.

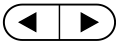

Follow the instructions below to select and configure the GPIB interface for remote operation.

1. From the **Config** menu, select **Communication** then press .
2. Use the  keys to select the **GPIB** option then press .
3. Configure the GPIB **Communication Address** to which the power supply will be assigned. Use the rotary numeric keypad  keys or rotary knob to enter an **Address** value from 1-31 then press .
4. Make sure the address assigned to the power supply unit matches the address the data commands are being sent to.

## 4.2 Remote Commands

The instrument supports some SCPI commands and some instrument specific commands. These commands enable a computer to remotely communicate and control the power supply over any of the supported remote interfaces: USB, RS-232, and LAN for all units. In addition, the 9803 and 9805 also have a GPIB interface.

Refer to the programming manual for details, which can be downloaded from [www.bkprecision.com](http://www.bkprecision.com).

## 5 Troubleshooting Guide

Below are some frequently asked questions and answers. Please check if any apply to your power supply before contacting B&K Precision.

### **General**

**Q: I cannot power up the power supply.**

- Check that the power cord is securely connected to the AC input and there is live power from your electrical AC outlet.
- Verify that the AC power coming from the mains have the correct voltage. The power supply can accept a specific range of AC input voltages. Refer to section "2.1".

**Q: How come my display voltage is lower than the voltage I set?**

- This is often because of the resistances from the test leads/wires connected between the supply and the DUT (device under test), which causes a drop in voltage. To minimize this drop, use remote sense terminals to compensate and output a more accurate voltage to the DUT.

**Q: Why can't I set voltage and/or frequency under or over a specific limit?**

- This may be that the set voltage and/or frequency is outside of the set limits in the menu settings. Refer to the voltage limits section under "[Voltage Limits](#)" or frequency limits under "[Frequency Limits](#)" to verify and configure these limits.

**Q: Why does my output waveform look cut off and distorted on my oscilloscope?**

- Check to see if the dimmer function is enabled. If it is, it is likely the result of the phase being cut, which results in a distorted waveform. This also leads to less RMS voltage. See the [Dimmer Output Simulation](#) section for more information.

## ***Remote Control***

**Q: I am trying to send the commands over USB/RS232, but it does not seem to respond.**

- Check that you are sending ASCII strings that are terminated with a CR (carriage return) and LF (linefeed) character.
- For RS-232, check that the baud rate, parity, data bits, stop bit, and flow control settings match with the settings configured on the software interface.
- Check that pins 2 and 3 are not crossed.

## 6 Specifications

**Note:** All specifications apply to the unit after a temperature stabilization time of 15 minutes over an ambient temperature range of 25 °C ± 5 °C. Specifications are subject to change without notice.

Model		9801	9803	9805
<b>AC Input</b>				
Phase		Single		
Voltage		110 / 220 VAC ± 10%		
Frequency		47 – 63 Hz		
Current		8 A max.	15 A max	30 A max
Power Factor		0.5 (typical)	0.7 (typical)	0.7 (typical)
<b>AC Output</b>				
Max. Power		300 VA	750 VA	1500 VA
Max Current (rms)	0 – 150 V	3 A	6 A	12 A
	0 – 300 V	1.5 A	3 A	6 A
Max Current (Peak)	0 – 150 V	9 A	18 A	36 A
	0 – 300 V	4.5 A	9 A	18 A
Phase		Single		
Total Harmonic Distortion (T.H.D)		≤ 0.5% at 45 – 500 Hz (Resistive Load)		
Line Regulation		0.1 % max for a ± 10% line change		
Load Regulation		≤ 0.5% FS (Resistive Load)		
Response Time		< 100 μs		
<b>Programming</b>				
Voltage (rms)	Range	0 – 300 V, 150 / 300 V (Auto)		
	Resolution	0.1 V		
	Accuracy	± (0.2% + 0.6 V)		
Frequency	Range	45 – 500 Hz		
	Resolution	0.1 Hz at 45 – 99.9 Hz 1 Hz at 100 – 500 Hz		
	Accuracy	± 0.1 Hz (< 100 Hz) ± 1 Hz (100 – 500 Hz)		
Phase Angle	Range	0 – 360 °		
	Resolution	0.1 °		
	Accuracy	± 1° (45 – 65 Hz)		
<b>Measurement</b>				
Voltage (rms)	Range	0 – 300 V		
	Resolution	0.1 V		
	Accuracy	± (0.2% + 0.6 V)		
Current (rms)	Range*	Low: 120 mA / Mid: 1.2 A High: 3 A*	Low: 120 mA/Mid: 1.2 A High: 6 A*	Low: 120 mA / Mid: 1.2 A High 12 A*
	Resolution	Low: 0.1 mA / Mid: 1 mA / High: 10 mA		
	Accuracy	Low: ± (0.2% + 0.4 mA) / Mid: ± (0.2% + 4 mA) / High: ± (0.2% + 20 mA)		
Current (peak)	Range	0 – 9 A	0 – 18 A	0 – 36 A
	Resolution	0.01 A		
	Accuracy	± (1% + 120 mA)		
True	Resolution	L: 0.01 W / M: 0.1 W / High: 1 W		

Power(W)	Accuracy (47 – 65 Hz)	Low: $\pm (0.2\% + 0.05 \text{ W})$ / Mid: $\pm (0.2\% + 0.5 \text{ W})$ / High: $\pm (0.2\% + 2 \text{ W})$		
Frequency	Range	45 – 500 Hz		
	Resolution	$\pm 0.1 \text{ Hz}$ (45 – 99.9Hz) $\pm 1 \text{ Hz}$ (100 – 500 Hz)		
	Accuracy	$\pm 0.1 \text{ Hz}$		
Power Factor	Range	0.000 – 1.000		
	Resolution	0.001		
	Accuracy	True Power (W) / Apparent Power (VA)		
Apparent Power (VA)	Resolution	Low: 0.01 VA / Mid: 0.1 VA / High: 1 VA		
	Accuracy	Voltage (rms) x Current (rms)		
Temperature Coefficient (typical)		$\pm 0.04\%$ per °C		
<b>General</b>				
Memory		10 locations		
External BNC, input/output		Trigger input, sync output, output status, output indicator/control		
Interface		LAN, USB, and RS232. GPIB (9803 & 9805 only)		
Operating Environment		0 – 40 °C, 20 – 80% RH		
Dimensions (W×H×D) (mm)		214.5 × 88.2 × 453.5	439 x 131.4 x 535.7	439 x 131.4 x 535.7
Weight		9.5 kg	40 kg	52.2 kg

\* The current range switches from low to mid-range or mid to high range when  $I_{\text{peak}} > 300\%$  of the present range. When  $I_{\text{peak}}$  is  $<80\%$  of the high range, the current range switches from high to mid-range. When  $I_{\text{peak}}$  is  $<20\%$  of the mid-range, the current range switches from mid to low range.

To ensure the most current version of this manual, please download the latest version here:  
<http://www.bkprecision.com/search/9801>

For current up-to-date product information, please visit [www.bkprecision.com](http://www.bkprecision.com)

## Calibration

We recommend a calibration interval of once per year to ensure that the power supply meets specifications.



# SERVICE INFORMATION

---

**Warranty Service:** Please go to the support and service section on our website at [www.bkprecision.com](http://www.bkprecision.com) to obtain a RMA #. Return the product in the original packaging with proof of purchase to the address below. Clearly state on the RMA the performance problem and return any leads, probes, connectors and accessories that you are using with the device.

**Non-Warranty Service:** Please go to the support and service section on our website at [www.bkprecision.com](http://www.bkprecision.com) to obtain a RMA #. Return the product in the original packaging to the address below. Clearly state on the RMA the performance problem and return any leads, probes, connectors and accessories that you are using with the device. Customers not on an open account must include payment in the form of a money order or credit card. For the most current repair charges please refer to the service and support section on our website.

Return all merchandise to B&K Precision Corp. with prepaid shipping. The flat-rate repair charge for Non-Warranty Service does not include return shipping. Return shipping to locations in North America is included for Warranty Service. For overnight shipments and non-North American shipping fees please contact B&K Precision Corp.

B&K Precision Corp.  
22820 Savi Ranch Parkway  
Yorba Linda, CA 92887  
[www.bkprecision.com](http://www.bkprecision.com)  
714-921-9095

**Include with the returned instrument your complete return shipping address, contact name, phone number and description of problem.**

# LIMITED TWO-YEAR WARRANTY

---

B&K Precision Corp. warrants to the original purchaser that its products and the component parts thereof, will be free from defects in workmanship and materials for a period of two years from date of purchase.

B&K Precision Corp. will, without charge, repair or replace, at its option, defective product or component parts. Returned product must be accompanied by proof of the purchase date in the form of a sales receipt.

To help us better serve you, please complete the warranty registration for your new instrument via our website [www.bkprecision.com](http://www.bkprecision.com)

**Exclusions: This warranty does not apply in the event of misuse or abuse of the product or as a result of unauthorized alterations or repairs. The warranty is void if the serial number is altered, defaced or removed.**

B&K Precision Corp. shall not be liable for any consequential damages, including without limitation damages resulting from loss of use. Some states do not allow limitations of incidental or consequential damages. So the above limitation or exclusion may not apply to you.

This warranty gives you specific rights and you may have other rights, which vary from state-to-state.

B&K Precision Corp.  
22820 Savi Ranch Parkway  
Yorba Linda, CA 92887  
[www.bkprecision.com](http://www.bkprecision.com)  
714-921-9095

**BK PRECISION<sup>®</sup>**

22820 Savi Ranch Parkway  
Yorba Linda, CA 92887  
[www.bkprecision.com](http://www.bkprecision.com)

© 2019 B&K Precision Corp.